

552

HD Radio® Modulation Monitor

Installation & User Guide



PRODUCT REGISTRATION RECORD

552 – Serial No. _____

Purchase Date _____

Warranty Registered via Web?

Reg. Date _____ By: _____

Installation & Operation User Guide

552

 **Radio** Modulation Monitor

August, 2025

Firmware Rev. 1.3.1.0 (Added DTAC Interface)

Inovonics, Inc. 5805 Highway 9

Felton, CA 95018

Tel: (831) 458-0552

Register online at www.inovonicsbroadcast.com

HD Radio Technology is manufactured under license from iBiquity Digital Corporation. U.S. and Foreign Patents apply. For patents see <http://patents.dts.com/>. HD Radio and the HD, HD Radio and "ARC" logos are registered trademarks of iBiquity Digital Corporation in the United States and/or other countries.

TABLE OF CONTENTS

Section I – INTRODUCTION

| | |
|-------------------------------|----------|
| 552 PRODUCT DESCRIPTION | |
| Introduction | 5 |
| Product Features | 5 |
| 552 TECHNICAL SPECIFICATIONS | |
| Specifications | 6 |
| Block Diagram | 8 |

Section II – INSTALLATION

| | |
|---|-----------|
| GENERAL | |
| Unpacking and Inspection | 9 |
| MOUNTING, POWER AND ENVIRONMENT | |
| Rack Requirement | 9 |
| Heat Dissipation | 9 |
| AC Mains Power | 10 |
| Radio Frequency Interference (RFI) | 10 |
| Ground Loops | 10 |
| INPUTS, OUTPUTS AND PORTS | |
| Antenna Input and Considerations | 10 |
| High Level Input | 10 |
| Multiplex or Pilot Sync Output | 10 |
| Program Line Outputs | 10 |
| 'Assignable' Line Outputs | 11 |
| The 'Split Mode' | 11 |
| Analog Line Output Characteristics | 11 |
| AES Digital Line Output | 11 |
| AoIP Streaming Port and Levels | 11 |
| LAN Network Port | 12 |
| GPOs | 12 |

Section III – PREPARING TO CONNECT

| | |
|--|-----------|
| THE 552 FRONT PANEL | |
| Front Panel vs. Network Operation | 13 |
| Powering-Up | 13 |
| Navigating the OLED Display | 13 |
| Screen Settings (A Setup Example) | 13 |
| Toggled Commands | 14 |
| Front-Panel Setup Notes and Menu Tree | 14 |

| | |
|---|----|
| BRINGING UP THE WEBPAGE SERVER | |
| Network Considerations | 15 |
| Finding the 552 IP Address | 15 |
| Connecting | 15 |

Section IV – USING THE WEB INTERFACE

| | |
|---|----|
| Internal Webserver | 16 |
| The Menu List | 16 |
| ‘Responsive’ Webpages | 16 |
| THE WEBPAGE HEADER | |
| Monitor ID | 16 |
| Station ID | 16 |
| Presets | 16 |
| Remote Listening | 16 |
| Other Stream-Listening Options | 17 |
| NOW PLAYING | |
| Reception Status-In-Brief | 17 |
| The Alarm Panel | 18 |
| Tuning the 552 | 19 |
| Station Presets | 19 |
| Important! | 20 |
| Specifying the Four ‘Selected’ HD Programs | 20 |
| RF Input Selection | 20 |
| Mono/Stereo | 20 |
| STATION ROTATION™ | |
| StationRotation Defined | 20 |
| FM LEVEL METERING | |
| FM Carrier Modulation | 22 |
| Pilot and Subcarriers | 22 |
| Demodulated FM Audio | 23 |
| FM Program Loudness | 24 |
| ITU-R BS.1770 Loudness Measurement | 24 |
| Synchronous and AM Noise | 25 |
| HD LEVEL METERING | |
| HD Levels and Loudness | 25 |
| Relative HD Program Loudness | 25 |
| SPECTRUM PLOTS | |
| The IF Spectrum | 27 |
| The FM Baseband Spectrum | 28 |
| Audio Spectrum Display | 28 |
| HISTORY PLOTS | |
| History Screen Basics | 29 |
| Modulation | 29 |
| RF Metrics | 30 |
| Audio History | 30 |
| Integrated Loudness History | 30 |
| OSCILLOSCOPE | |
| O-Scope Applications | 31 |
| Audio XY Display | 31 |

| | |
|---|----|
| FM AND HD1 ALIGNMENT | |
| Specs at-a-Glance..... | 32 |
| Alignment Time Studies | 32 |
| DTAC Operation with the GatesAir FMXi-4g Exciter..... | 33 |
| Warnings!..... | 33 |
| THE BANDSCANNER™ UTILITY | |
| Warnings!..... | 34 |
| Start Scanning..... | 35 |
| Bars and Dots..... | 35 |
| THE LISTENER EXPERIENCE | |
| Definition | 36 |
| Display Options..... | 36 |
| Image Error Reporting | 37 |
| Additional Image Data..... | 38 |
| RDS AND HD METADATA | |
| RDS Info | 38 |
| HD Info..... | 38 |
| ALARMS | |
| Alarm Status..... | 40 |
| Set the Clock!..... | 40 |
| Important!..... | 40 |
| Overmod..... | 41 |
| 'Hysteresis' Type Alarms..... | 41 |
| FM Audio Loss | 41 |
| Low Signal Mute..... | 42 |
| Pilot Loss | 42 |
| Multipath..... | 42 |
| RDS Alarms | 42 |
| RDS RadioText Not Updated | 43 |
| RDS CT Out of Range | 43 |
| RDS TMC Not Received | 43 |
| SCA Loss..... | 43 |
| HD Audio Loss | 43 |
| HD Loss..... | 43 |
| HD Program Loss..... | 43 |
| HD Power Out of Range..... | 44 |
| FM/HD1 Alignment Out of Range | 44 |
| HD PSD Not Updated | 44 |
| HD Logo Not Received..... | 44 |
| HD Artist Experience Not Updated..... | 45 |
| HD Image Issues | 45 |
| HD TMC Not Received..... | 45 |
| HD Emergency Alerts..... | 45 |
| Alarm Logging..... | 45 |
| SETUP | |
| Radio Settings..... | 46 |
| MPX Output | 46 |
| Assignable Audio Outputs | 46 |
| Dante/AoIP Streams..... | 47 |
| Other Streaming Options..... | 47 |
| HTTP/Icecast Setup..... | 47 |
| UDP Streaming..... | 47 |
| Save the Settings!..... | 47 |
| General Purpose Outputs | 48 |

| | |
|-----------------------------------|-------------------|
| NETWORK SETUP AND INTERNET ACCESS | |
| IP Setup | 49 |
| Assigning a Hostname..... | 49 |
| HTTP Port | 49 |
| MAC Address | 49 |
| Link Speed..... | 49 |
| Addressing the 552..... | 49 |
| Incoming Internet Access..... | 49 |
| DANTE® AND AoIP STREAMING | |
| IP Settings Mode | 50 |
| AES67 Enable..... | 50 |
| The AoIP MAC Address | 50 |
| Link Speed..... | 51 |
| Audio Format | 51 |
| Transmit Flows..... | 51 |
| The Dante Controller..... | 51 |
| SNMP OPERATION | |
| Overview..... | 51 |
| Mode..... | 51 |
| Security | 52 |
| Ports | 52 |
| Trap Destinations..... | 52 |
| The MIB File..... | 52 |
| EMAIL | |
| Email and Text Notifications..... | 52 |
| SMTP Setup..... | 52 |
| Recipients (Send To)..... | 53 |
| Notifications (Send What)..... | 53 |
| TIME SETUP | |
| Time and DST..... | 54 |
| Presentation Formats | 54 |
| RTC Battery | 54 |
| Time Server | 54 |
| ADMINISTRATIVE MATTERS | |
| Security and Passwords | 54 |
| Signing In | 55 |
| Lost Password (Hard Reset)..... | 55 |
| The Hardware Profile | 55 |
| Reboot | 56 |
| Updating Firmware..... | 56 |
| 552 Manual | 57 |
| 'About' Info..... | 57 |
| INOVONICS WARRANTY | INSIDE BACK COVER |

Section I

INTRODUCTION

552 PRODUCT DESCRIPTION

Introduction The Inovonics 552 HD Radio Modulation Monitor gives the FM radio broadcaster access to extensive signal parameter data, for both the analog-FM host transmission and all accompanying HD Radio® digital channels.

The all-digital 552 combines detailed DSP signal analysis with Webpage-based access for remote operation, measurements, graphical data and audio monitoring.

Product Features

Leading features of the Inovonics 552 include:

- Get this monitor up and running using the front panel knob and OLED display. A built-in Web server then gives full menu-driven access for complete operational control over any IP network by computer or mobile device. The 552 supports full SNMP remote control and monitoring.
- Unexcelled off-air reception of analog-FM and FM/HD Radio programs HD1-HD8; accurate FM total-mod and other measurements with HD Radio carriers at any level. Stays on-channel and on-mode through signal and power loss.
- Graphic Webpage display of all level metering; FFT spectrum analysis of IF passband, MPX baseband and program audio; oscilloscope, audio XY and ITU-R BS.1770 ('LU') loudness displays. Collects and logs a history of FM and HD Radio signal parameters.
- Precise analysis of timing and level errors between analog FM and HD1 digital program channels.
- Simultaneous monitoring of analog FM and four user-selected HD Radio programs. Analog, AES3-digital, HTTP/UDP Web-streaming and independent AoIP-streaming program audio outputs, plus an FM composite/MPX baseband output.
- Displays FM/RDS and HD/PAD data in real time; Webpage presentation of station logos and 'Artist Experience' album art.
- Alarms for a wide range of individual signal faults, with tallies and SMS text or email message dispatches to specific individuals for various alarm conditions. Logs all alarms chronologically.
- BandScanner™ utility scans the FM spectrum and displays each station with its signal level, PI code, callsign, PTY and HD status.
- StationRotation™ mode enables automatic sequential monitoring of multiple stations.

552 TECHNICAL SPECIFICATIONS

PLEASE NOTE: All specifications noted here are actual, real-world measurements, not optimistic allusions to theoretical ideals. Measurements should be repeatable when using appropriate test equipment.

Tuning Range: 87.5MHz-107.9MHz in 100kHz steps.

Antenna Input: 75-ohm (F), 1V_{RMS} max.

High Level RF Input: 50-ohm (BNC), 5V_{RMS} max.

Sensitivity/SNR: 15dB μ V required for 50dB Mono-FM SNR, unweighted; 5dB μ V with de-emphasis.

Reception Modes:

FM: Stereo / Forced Mono

HD Radio: HD1 through HD8

FM/HD1: 'Split Mode' delivers L+R FM to the left audio channel and L+R HD1 to the right.

FM De-emphasis: Menu-selected 75 μ s, 50 μ s or None

Off-Air Frequency Response:

FM: \pm 0.1dB, 20Hz-15kHz

HD Radio: \pm 0.25dB, 20Hz-20kHz

MPX Out:

\pm 0.1dB, 10Hz-60kHz

-0.25dB max at 90kHz

-0.45dB max at 100kHz

Stereo Separation:

FM: >60dB, 20Hz-15kHz

HD Radio: >90dB, 20Hz-20kHz

FM Stereo Crosstalk (M \rightarrow S / S \rightarrow M): >74dB, 20Hz-15kHz, analog or digital out.

Distortion (THD):

FM: <0.01%, 20Hz-15kHz

HD (AES Digital Out): <0.003%, 20Hz-20kHz

HD (Analog Out): <0.004%, 20Hz-20kHz

MPX Out: <0.02% THD, unweighted

Signal-to-Noise:

FM (AES Digital Out):

Unweighted Mono: >84dB

50 μ s Mono: >91dB

75 μ s Mono: >93dB

Unweighted Stereo: >70dB

50 μ s Stereo: >76dB

75 μ s Stereo: >77dB

FM (Analog Out):

Unweighted Mono: >80dB

50 μ s Mono: >88dB

75 μ s Mono: >89dB

50 μ s Stereo: >67dB

75 μ s Stereo: >75dB

HD (AES Digital Out): >83dB

HD (Analog Out): >80dB

Program Audio Outputs:

Balanced Analog: (XLR) Left and Right outputs adjustable from -15dBu to +15dBu in 0.1dB steps; 200 Ω source.

AES Digital: (XLR) Adjustable from -30dBFS to 0dBFS in 0.1dB steps; 44.1kHz sample rate; 110 Ω transformer-coupled.

Dante/AES67 Compatible: (RJ45) Output at 44.1kHz (Dante-only) or 44.1kHz/48kHz (Dante /AES67); AoIP utility has independent IP, Audio Format and Transmit Flow settings; level adjustable from -30dBFS to 0dBFS in 0.1dB steps.

Headphone Jack: (1/4" TRS) with adjustable listening level.

Listening Stream: Web browser remote-listening stream employs HE-AACv2 encoding, 44.1kHz or 48kHz sample rate, bit-rates from 18kbps to 64kbps; accommodates up to 10 simultaneous listeners. HTTP/Icecast and raw UDP streams are available simultaneously.

Composite/MPX Output:

(BNC) may be switched between MPX and 19kHz stereo pilot sample; adjustable from 1V_{PP} to 6V_{PP} in 0.01V steps.

LAN Port:

(RJ45) LAN connection to local network or Internet provides remote monitoring, control, listening and full SNMP implementation; user-programmable network setup and streaming parameters.

General Purpose Outputs: (Barrier Strip) Ten individual open-collector NPN transistor closures to ground are associated with alarm functions. Each is programmable for GPO assignment and logic polarity. Outputs sink 100mA, 40VDC max.

RDS Fields Displayed:

PS • PI • Call • RT • RT+1 • RT+2 • PTY • PTYN • CT • M/S • DI • TP • TA • AF • ODA • Block Error Rate • Groups & use statistics.

HD PAD Data Displayed:

Overview: Short Name • Universal Name • Station ID • Slogan • Message • Station Location • Service Mode • TX Blend • Emergency Alert.

HD1-HD8 (each): Slogan • Program Type • Artist • Title • Album • Codec Mode • Bitrate • TX Gain • Logo/Artist Experience graphics and file details.

(continued)

Bargraph & Numerical Level Metering:

Analog FM: Carrier Modulation • Stereo Pilot & Subcarriers • Demodulated L/R & L+R/L-R • Stereo Separation • Stereo Crosstalk • BS.1770 Loudness • Synchronous & AM Noise.

HD Radio:

L/R Audio • BS.1770 Loudness (absolute and relative to Analog FM Loudness). *(Presented simultaneously for HD1 and three other selected HD programs.)*

FM/HD1 Alignment: Timing offset and level and phase discrepancies between programs; 'Confidence Factor' display.

Graphic Displays/Plots:

IF Spectrum • MPX Spectrum • Audio Spectrum • Audio O'scope • Audio XY • FM Modulation History • Audio Level History • Metrics History • FM/HD1 Time & Level Alignment History • BandScanner™ utility.

Alarms:

Most alarms have multiple parameter settings. All alarms can send text or email notifications. Alarms are also logged: daily, weekly, monthly.

Analog FM: Overmod • FM Audio Loss • Low Signal • Pilot Loss • Multipath • RDS Loss • RDS PI Error • RDS RT • RDS CT • RDS TMC • SCA Loss.

HD Radio: HD Loss • HD Program Loss • HD Power • FM/HD1 Alignment • HD1 Audio Loss • HDA Audio Loss • HDB Audio Loss • HDC Audio Loss • HD Logo • HD Artist Experience • HD Image Issues • HD TMC • HD Emergency Alerts.

Real-Time Clock:

Auto-sets to Internet time; auto/manual DST setting; battery backup.

Power Requirement:

88-264VAC, 15W.

Operating Environment: 32°F/0°C-

122°F/50°C; 0%-95% non-condensing relative humidity; 10,000ft/3048m

Size and Weight:

1.75"H x 19"W x 9"D; 7 lbs. shipping weight.

Conformances:



EN50081-1
EN50082-1
93/68/EEC



2002/95/EC

BLOCK DIAGRAM

The 552 incorporates a Software-Defined Radio (SDR) receiver and similar elements in its design that make the product almost entirely DSP-based. Virtually all functionality is provided through firmware coding. The Block Diagram presented below illustrates product basics in an easily-understood form, although actual signal paths and logical functions may deviate appreciably from those depicted here.

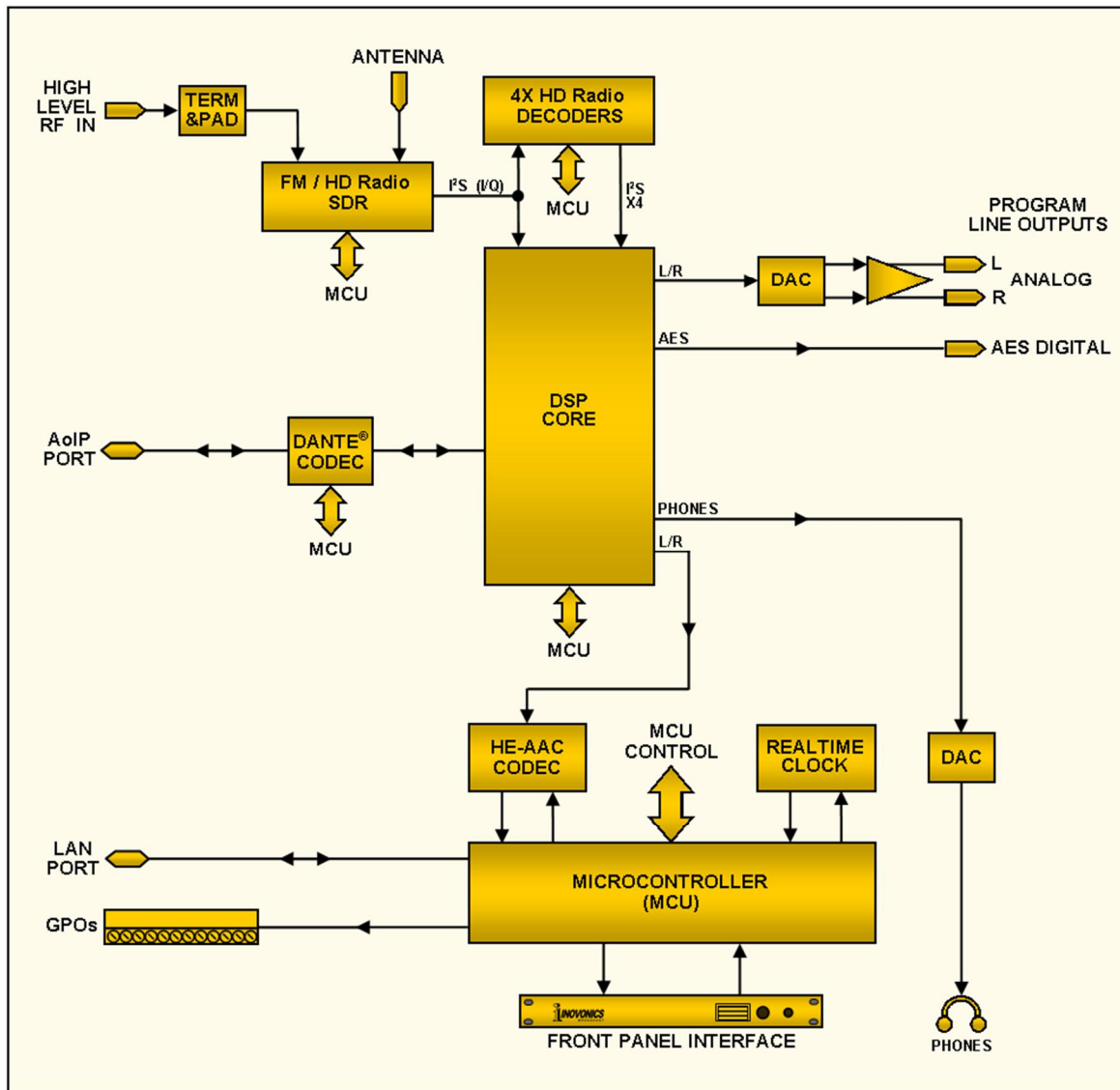

Block Diagram of the Inovonics 552 HD Radio Modulation Monitor

Section II

INSTALLATION

GENERAL

This section of the manual addresses the physical installation of the 552 at its operating location, the 'nuts and bolts' of connecting the unit. This section also references pages where pertinent setup options and adjustments are discussed.

Unpacking and Inspection

As soon as the equipment is received, inspect carefully for any shipping damage. If damage is found or suspected, notify the carrier at once, and then contact Inovonics.

We recommend that you retain the original shipping carton and packing materials for possible return or transshipment. If returned for Warranty repair, shipping damage sustained as a result of careless packing for return may invalidate the Warranty!

IT IS IMPORTANT to register the Warranty of your 552. This assures coverage of the equipment under Warranty terms, provides a means of tracing lost or stolen gear, and adds the user to a database to receive specific service instructions or software/firmware updates when issued. Register online at:

www.inovonicsbroadcast.com/support/productRegistration

NOTE: Many users choose first to familiarize themselves with equipment on the bench or at their desk, in which case they may immediately turn to Section III that describes setup and use of the 552 monitor. When the time comes, do please refer back to this section to confirm proper physical installation and interconnection with other station equipment.

MOUNTING, POWER AND ENVIRONMENT

Rack Requirement

The 552 is a 1U rack-mount package, occupying a nominal 1¾ inches of vertical rack space.

Heat Dissipation

A power-frugal product, the 552 generates very little heat itself and is specified for operation within an ambient temperature range between freezing and 120°F/50°C. Because adjacent, less-efficient gear may radiate substantial heat, be sure that the equipment rack is adequately ventilated to keep internal temperature below the specified maximum ambient.

- AC Mains Power** The 552 employs an internal ‘universal’ switchmode power supply that accommodates mains voltages between 88VAC and 264VAC. Certified self-protection circuits have replaced the once-familiar fuseholder.
- If you need to replace the North-American mains plug with another, you will find that the individual cord conductors are color-coded in one of two ways. US standards specify black for AC ‘hot,’ white for AC neutral and green for earth ground. European CEE standards specify brown for AC ‘hot,’ blue for AC neutral and green with a yellow stripe for earth ground. It is incumbent upon you to follow this coding strictly.
- Radio Frequency Interference (RFI)** Although it is expected that the 552 will be co-located with other radio equipment, do practice care and common sense in locating the unit away from abnormally high RF fields.
- Ground Loops** A mains frequency or RF ground loop could possibly be formed between cable shield grounds and the AC power cord ground. If hum or other constant noise is noted in analog outputs, a ‘ground-lifting’ AC adapter may remedy the problem, although the chassis must somehow be returned to earth ground for safety. Rack-mounting the chassis normally satisfies this requirement.

INPUTS, OUTPUTS AND PORTS

- Antenna Input and Considerations** The rear-panel ANTENNA connector is a female, 75-ohm F connector. While the F is a common standard in the US, adapters to other connector types are readily available worldwide.
- Factors guiding your selection of an antenna will include the level and purity of the off-air signal. Selectivity of the 552 is remarkably good, but as a wideband receiver you may need a band-pass or band-stop filter for certain situations where the 552 and high power transmitters are co-located.
- High Level Input** The rear-panel HIGH LEVEL RF INPUT is a 50-ohm-terminating BNC input meant to connect directly to a transmitter or coupler tap as an alternative to off-air signal reception. Maximum input voltage should not exceed 5VRMS. Input selection is made under the Tuner menus.
- Multiplex or Pilot Sync Output** The rear-panel MPX OUT BNC connector delivers either the FM baseband signal or a 19kHz stereo pilot-sync sample. Mode selection and output level adjustment is made from Webpage Setup menu. The output may be varied between 1VPP and 6VPP.
- Program Audio Outputs** The 552 monitor simultaneously demodulates the main-carrier analog-FM program, the accompanying HD1 digital-audio program and, selectively, any three of the remaining HD Radio program channels, HD2 through HD8. The three selected channels, initially identified as HDA, HDB, and HDC, may be user-selected independently for each station tuned.

| | |
|---|--|
| 'Assignable' Line Outputs | Analog and digital line outputs are XLR male connectors on the rear panel. These may be independently assigned to any program channel: FM, HD1, HDA, HDB, or HDC, plus the FM/HD1 'split' listening mode. Assignment is under the Setup Webpage menu under Audio Outputs, where line levels for may be adjusted independently as well. |
| The 'Split Mode' | When the assignable line output is set to FM/HD1, you'll hear the HD1 program in the left channel and the FM program in the right. Any audible delay, echo or 'hollowness' justifies a look at your Diversity Delay exciter or processor settings. Be sure to turn off the Split Mode after listening for program sync. |
| Analog Line Output Characteristics | LEFT and RIGHT ANALOG OUTPUT(S) on the rear panel are electronically-balanced XLR male connectors. These are ground-referenced and <i>not</i> transformer-isolated. Analog outputs have a resistive source impedance of 200 ohms. Levels are expressed in dBu (unloaded) notation next to the Webpage adjusting sliders. Although seldom seen in modern times, a legacy 600-ohm-terminating load will drop the actual dBm level 2.5dB below the figure shown beside the associated adjusting slider. An unbalanced output should be taken from the 'hot' or '+' side of any analog output and ground, leaving the 'return' or '-' side of the output floating. The unbalanced output level will be 6dB below the figure shown beside the slider. Analog levels may be set to any figure between -15dBu and +15dBu, corresponding to 100% FM carrier or HD program modulation. The default setting is +4dBu. |
| AES Digital Line Outputs | The AES DIGITAL OUTPUT delivers the balanced, transformer-coupled AES3 digital stereo program from a source impedance of 110 ohms. These are 24-bit outputs at a 44.1kHz sample rate. AES digital levels may be set between -30dBFS and 0dBFS, corresponding to 100% FM carrier or HD program modulation. The default setting is -10dBFS. |
| AoIP Streaming Port and Levels | The Dante-compliant AoIP (Audio over Internet Protocol) outputs appear at the rear-panel RJ45 AoIP PORT, with simultaneous transport of FM, HD1, HDA, HDB and HDC program channels. This port is independent of the 552 LAN PORT network connection and its 'casual streaming' utility. Dante/AoIP streaming first requires basic Dante setup under the Webpage Dante menu as detailed on Page 50. Output levels are adjusted on the Setup / Audio Outputs / Dedicated Outputs / Dante/AoIP Webpage. The dB notation beside each slider control corresponds to the level of program peaks at 100% FM or HD Radio modulation. These are adjustable between 0dBFS and -30dBFS; the default setting is -10dBFS. |

- LAN Network Port** The RJ45 LAN PORT connects the 552 to a Local Area Network (LAN) or the Internet. Network setup is under the Webpage or OLED Network menu as detailed later in the appropriate section. Networking enables remote control, full SNMP functionality, and the HTTP/UDP Web-browser 'casual listening' utility.
- GPOs** A removable screw-terminal strip on the rear panel accesses ten GENERAL PURPOSE OUTPUTS (GPO) terminals for 552 alarm 'tallies.' GPOs are NPN transistors that saturate to ground and can sink up to 100mA at 40V max. Alarm polarity (active ground or active open) is software-programmable. GPOs may be assigned to the various reception and program-fault alarms as described on Page 48.

Section III

PREPARING TO CONNECT

THE 552 FRONT PANEL

Front Panel vs. Web Interface Operation

Setup and operating adjustments of the 552 are under firmware control; there are no jumpers, switches or mechanical potentiometers. The unit may be set-up initially through the front-panel OLED display and knob, although this offers a very limited range of readouts and adjustments. Your purchasing choice of a 552 insinuates a preference for using the built-in Webserver interface for everyday interaction between the 552 and your choice of any networked computer, tablet or mobile device with a Web browser.

You will at least need to access the front-panel OLED screen to find the unit's IP address, so some familiarity with the front panel is useful.

Powering-Up

'Boot' (startup) time of 552 is just under ten seconds. When power is first applied, or following a power interruption, the unit is back in full operation in short order. Setup and reception parameters in effect previous to a power glitch are reloaded instantly from non-volatile memory into the processing core.

Navigating the OLED Display

The OLED display has an adjustable timeout feature with a factory default at the timer's 5-minute minimum. The display will either dim or turn off at the end of the timeout. Pressing or turning the knob will wake the display and reset the timer. Above is a snapshot of a portion of the Main Menu you will see at boot-up.



Screen Settings (A Setup Example)

For this demonstration, *turn* the knob to navigate down the list to the **Display** menu shown at the right, and then *press* the knob to enter that menu screen shown below it. The lower image has been 'unrolled' here to make the complete **Display** menu visible. You can turn the knob and scroll down to bring the lower portion of a menu into view whenever necessary.

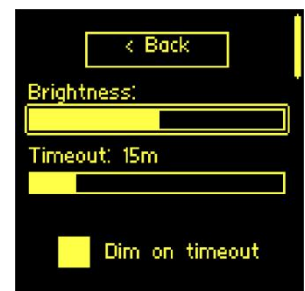
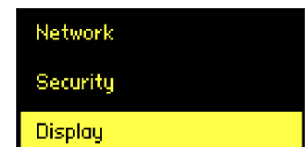

Once within the menu, turn the knob to highlight (outline) any parameter you wish to adjust. In this illustration the **Brightness:** bar has been highlighted. To

change **Brightness:**, first push the knob, and then turn it until the **Brightness:** level is set where you want it.

Push the knob again to exit the **Brightness:** adjustment. To return to the Main Menu, turn the knob until **< Back** is highlighted, and then push a final time.

Toggled Commands

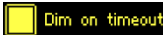
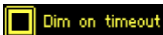
In the foregoing example, additional to the **Brightness:** and **Timeout:** 'slider' adjustments, note the **Dim on timeout** 'button' at the bottom. This, too, may be highlighted and changed along with similar buttons in other menus. A button is 'on' when it is filled:  **Dim on timeout** and 'off' when empty:  **Dim on timeout**

Front-Panel Setup Limitations

As the 552 is intended for remote monitoring and operation, it lacks the operational utility of its big brother, the 551 HD Mod-Monitor, a physically larger product with extensive front-panel appointments and display features. The 552 offers the same functionality, but depends highly on use of a computer, tablet or, if you must, a mobile phone for its control and display.

Discussions that follow assume use of Webpages screens for setup and operation of your 552. A few of the features are at least partially controllable from the front panel as noted in the Front Panel Menu Tree that follows. Main Menu titles are underlined, sub-items listed are followed by a key. **r/o** means readout only, other actions possible are indicated.

Now Playing

Freq and HD Programs **r/o**
RSSI **r/o**
SNR **r/o**
DSQM **r/o**
Cd/No **r/o**
HD Power **r/o**
Multipath **r/o**

Meters

Total Mod **r/o**
Pilot **r/o**
RDS **r/o**
SCA **r/o**
FM **r/o**
HD1 **r/o**
HDA **r/o**
HDB **r/o**
HDC **r/o**

Tuner

RSSI **r/o**
Cd/No **r/o**
Freq **r/o + tune radio**
HDA, HDB, HDC **assign to channels**
RF Input **select Antenna/Hi Level**
Stereo Mode **select Stereo/F-Mono**
SCA Freq **select None/67kHz/92kHz**
SCA BPF **select 4kHz-32kHz**
Station Rotation **on/off**
Rotation Time **r/o + set time**

Network

DHCP **on/off**
IP Address **r/o + enter address**
Subnet Mask **r/o + enter address**
Gateway **r/o + enter address**
DNS **r/o + enter address**
HTTP Port **r/o + enter port no.**
Hostname **r/o**
MAC Address **r/o**
Link Speed **r/o**

Security

Front Panel Pin **r/o + enter/change**
Web Admin Password **r/o**
Web User Password **r/o**

Display

Brightness **set**
Timeout **r/o + set timeout interval**
Dim on timeout **on/off**

Headphones

Headphone Volume **adjust level**
FM **listen to FM**
HD1 **listen to HD1**
HDA **listen to HD assigned to HDA**
HDB **listen to HD assigned to HDB**
HDC **listen to HD assigned to HDC**
FM/HD1 **listen to 'split mode'**

About

Firmware Rev **r/o**
Serial Number **r/o**
Uptime **r/o**
Time **r/o**
Date **r/o**
Battery **r/o**

BRINGING UP THE WEBPAGE SERVER

Network Considerations

To access the 552 Webserver interface, both the 552 and your computer must be on the same Local Area Network (LAN). As promised, the 552 can be accessed from a computer, tablet or phone anywhere in the world, but first your network needs to be set up to make this possible. This process is addressed in the Networking section later in the manual.

Finding the 552 IP Address

With both your computer and the 552 plugged into your LAN, and both turned on, go to the 552 front panel and bring up the **Network** menu.

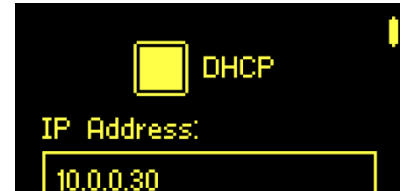

DHCP is the factory-default network mode, and the IP Address: assigned to the 552 by your router appears in the first box. DHCP should work for you at least initially, but if your 552 needs a static IP address, select the DHCP box and turn it off. This will unlock the various data-entry boxes underneath. As you then highlight each box, an on-screen keypad pops-up permitting you to overwrite the default entries. Once connected you may perform this operation much more easily using the Webpage interface as explained later.

Connecting

Bringing up the Webpages user interface is as simple as entering the IP address of the 552 into your browser's address bar and clicking Enter.

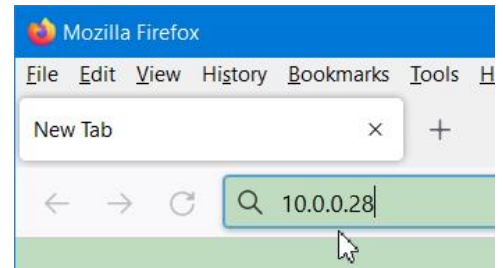

Alternatively, a Windows computer is able to locate and connect to the 552 by using the unit's 'Hostname' in place of the IP address. The Hostname is shown on the **Network** menu screen. The default Hostname: is MODEL552. This name may be changed to a more convenient or personalized identification of the unit, as may be required to differentiate between multiple units on the same LAN.

When you have connected you will see the Now Playing Webpage. Starting at this point in the manual, almost setup and operating discussions and instructions will use the Webpage interface utility, mainly because it's easier to navigate and type into.

Section IV

USING THE WEB INTERFACE

- Internal Webserver** The Inovonics 552 includes an internal Webserver that contains multiple interactive menu Webpages for setup and operation of your unit. These pages give ready and interactive access to all settings, readouts, graphics, audio monitoring and alarms.
- The Menu List** The 552 Web interface opens to the Now Playing page. A list of all the Webpage menus can be found at the left edge of any page. Click on any menu heading to go immediately to that Webpage.
- ‘Responsive’ Webpages** The ‘responsive’ 552 internal webserver provides an optimal viewing experience across a wide range of devices: desktop computers, tablets and mobile phones. Specific to the device, as the image size varies the Webpage is reconfigured to give the best view.

THE WEBPAGE HEADER

Each of the 552 Webpages carries the header shown here:



- Monitor ID** At the left, the hostname of the 552 identifies the specific unit connected. Feel free to specify a comprehensible hostname to differentiate between multiple units on the LAN. Enter the new hostname as described in the Networking section.
- Station ID** The tuned frequency and the HD Radio metadata Short Name is displayed below the hostname.
- Presets** On the right, the first button lets you change stations from among the presets that have been entered into memory. In the example header, none had been preset, so Not a Preset was displayed. Once stations are entered, clicking on the button will drop down the menu shown at the right, and then clicking one of the presets will re-tune to that station. Entering presets is covered here shortly.
- Remote Listening** Click the loudspeaker icon at the top-right of this or any other Webpage to listen to the off-air audio program through your Web browser.

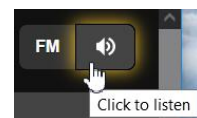
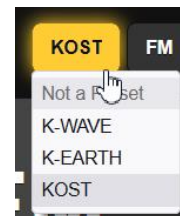

The button to the left of the loudspeaker lets you select which among the multiple programs you may listen to. The default is the main analog-FM program, but if HD Radio channels are available they may be selected here for listening.



Up to 10 listeners are able to access the audio stream simultaneously. This number may be restricted, however, and instructions are covered in the streaming audio discussion on Page 47.

Other Stream-Listening Options

You may safely give password-free listening access to personnel outside the engineering staff without giving away viewing or adjusting access to 552 Webpages. You will need to open a router port to use this IP-address method, but then one simply ‘points’ the computer or player (e.g.: VLC Media Player) at the desired audio stream as shown in the example that follows.

Streams are identified for this purpose as /stream0, /stream1, /stream2, /stream3 and /stream4, corresponding to the programs shown in the drop-down listening menu above, respectively. A browser address bar might resemble this example.



NOW PLAYING

You’ll find that the Now Playing Webpage and several of the others require you to scroll up and down to see everything, depending on the device you are using and its browser settings. Pages in this category will be discussed ‘sectionally,’ so prepare to scroll to see an item that’s being covered.

Reception Status-In-Brief

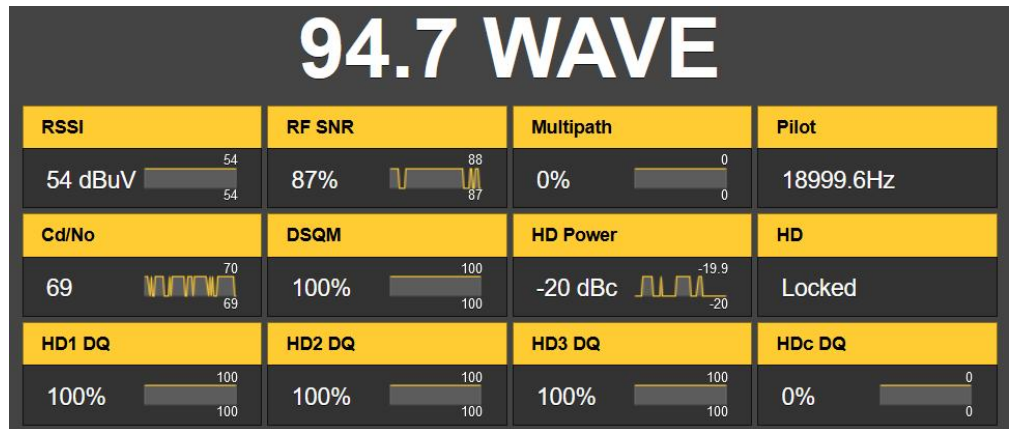

This top part of the Now Playing Webpage screen shows the most important incoming signal parameters. The frequency and HD Radio ‘short name’ are prominent above the matrix; non-HD stations will show only the frequency. Note that each readout box contains a tiny scrolling graphic that displays the subject level over time. Y-axis scaling is automatic with maximum/minimum figures for the time period are shown. Some of

these parameters, along with others not in this grid, are displayed graphically in much greater detail and with selectable time scaling on the History Plots Webpage.

Readouts in the top row give, in order: RSSI, the incoming FM carrier strength in dB (relative to 1 microvolt at the antenna input); RF SNR, or the RF signal-to-noise figure in percent relative to an ideal (100%) signal; Multipath distortion in the incoming signal, again relative to an 'ideal' value of zero; Pilot shows the 19kHz stereo-pilot frequency with 0.1Hz resolution.

The next two rows relate to the quality of the decoded HD Radio OFDM/HDC-coded carrier pair. HD Power is the 'dBc' figure for the level of the HD carrier pairs relative to the associated FM 'host' carrier level. HD simply indicates whether or not the HD Radio signal is locked-in by the receiver. The remaining measurements are expressed in percent and indicate signal 'confidence factor' with 100% equating to a perfect signal..

As just witnessed, much of the HD Radio terminology has been coined by the system developers and may not be familiar within all broadcast engineering circles. For an in-depth discussion of the HD Radio system, the reader is first directed to the relevant Wikipedia article here:

https://en.wikipedia.org/wiki/HD_Radio

Additionally, a bibliography at the end of the cited article will suggest further reading.

The Alarm Panel

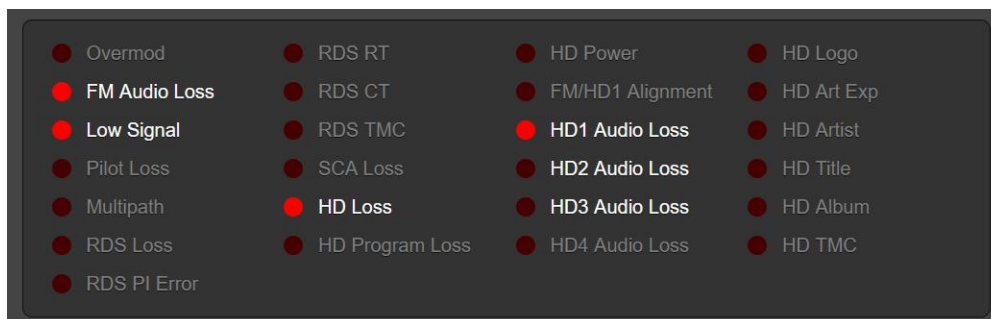

This field of alarm indicators lists reception fault alarms. Those that have been enabled by the user are noted in white text, grayed-out alarms are turned off. Once an alarm registers (as a function of signal level and on/off timing settings) the simulated red LED lights. The example above illustrates a station's signal lost, the only reason that the HD2 and HD3 Audio Loss indicators are not lit is that the alarm-on time for those two channels has not yet elapsed.

This Now Playing alarm panel is a duplicate of what's shown on the Alarms Webpage. Setup of the alarms is detailed in that discussion section.

Tuning the 552

The screenshot displays the 'Tuner HD 123' interface. At the top, the frequency is set to 94.7 MHz, with a slider and navigation buttons. Below this, there are three rows of HD program selection: HDA, HDB, and HDC. In the HDA row, HD2 and HD3 are selected (highlighted in orange). In the HDB row, HD3 is selected. In the HDC row, None is selected. The RF Input is set to Antenna, and the FM Stereo Mode is set to Stereo. The SCA Frequency is set to None, and the SCA BPF Bandwidth is set to 20 kHz. At the bottom, there are 'Save Changes' and 'Save as New' buttons. Below these buttons is a 'Preset Stations' list with 4 / 30 items. The list contains four entries: 1. 94.7 - K-WAVE (checked), 2. 95.5 - KLOS, 3. 91.5 - K-MOZART (checked), and an entry for 'Include this preset in StationRotation' (checked). Each entry has a close button (X) on the right.

This snapshot shows the Tuner subsection of the Now Playing Webpage. In this example the 552 is tuned to Los Angeles station KQAV at 94.7MHz, which carries HD1, HD2 and HD3 programs as indicated in orange in the header at the top.

You may tune the 552 by any of three methods. Mouse-grab the tuning slider and drag it up and down the dial, fine-tune in 100kHz increments by clicking on the < and > buttons, or overtype the frequency display at the left of the slider and hit Enter.

Station Presets

The 552 offers thirty station-memory presets. Once tuned to a station, click Save as New. This will open a box where you can enter call letters or a short 'street name' for the station. Then click Save in that same box and your entry will be entered at the bottom of the Preset Stations list. Presets are cleared from the list by clicking on the X at the right of the listing.

The Preset Stations list also contains all setup options and alarm settings *specific to each preset station* at the time it was entered

into memory. If you make changes to *any* option, the grayed-out Save Changes bar will immediately come alive as shown, prompting you to save the changes, assuming you want them updated.



Important!



Alarm programming instructions begin on Page 40. If you make any changes to alarm settings, or to the miscellaneous selections listed next, you *must return to the* Now Playing *Webpage* and click the Save Changes bar to permanently associate your changes with that preset.

Specifying the Four 'Selected' HD Programs

The 552 is able to decode any of the eight possible HD Radio programs, but can process only four programs simultaneously. HD1 is judged essential, thus leaving a choice of three others, HD2 through HD8, for your consideration. The chosen channels are called HDA, HDB and HDC.

The button matrix just below the tuning slider assigns HD programs to the HDA, HDB and HDC program channels of the 552. As the example station currently carries only HD2 and HD3 programming (in addition to the obligatory HD1), HD2 and HD3 have been assigned to HDA and HDB, and None assigned to HDC. These assignments, by the way, apply to the station currently tuned-in and will be part of the setup data saved as part of the Preset Stations listing. Therefore for other stations you may assign different HD Radio programs to HDA, HDB and HDC.

RF Input Selection

The 552 has rear-panel connectors labeled ANTENNA and HIGH LEVEL RF INPUT. The high-level BNC input is generally used when a direct connection to the transmitter is preferred over off-air signal reception.

On the Tuner Webpage menu, Antenna or High Level may be selected under RF Input. This selection also becomes a part of the Preset Stations data, allowing high-level input selection for your station and off-air reception for others, should you so wish.

Mono/Stereo

FM Stereo Mode: is Stereo by default, but may be changed to Force Mono if, for instance, the lower noise during mono reception is considered essential to some measurement.

SCA Reception Settings

The 552 is able to measure and display the injection level of SCA channels when the station broadcasts this auxiliary audio programming service as a 67kHz or 92kHz subcarrier. Select the subcarrier frequency and total SCA channel bandwidth desired for metering.

STATION ROTATION™

Although this feature appears on the Now Playing Webpage, it carries sufficient importance to warrant its own subheading here.

StationRotation Defined

A mod-monitor is historically employed as the station's full-time measurement utility, giving instant alarms for out-of-tolerance operation. Although the 552 easily fulfills this qualification, it has the added versatility of being able to 'ride herd' over multiple stations in the local market, with some expected compromise in its primary functionality.

The 552 has the built-in capability of sequencing through selected Preset Stations entries in the order listed, and at a rate set by the user. This might allow a contract engineer to receive alarms from any of a number of stations he might service in a given market. Stations are added to the StationRotation list by checking the box before a Preset Stations entry is saved.

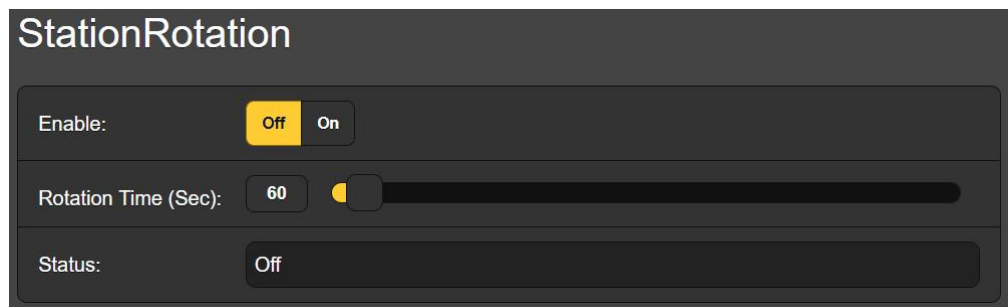

StationRotation must be turned on by setting Enable: to On. This will inhibit manual tuning, graying-out the manual Tuner setup section completely. Next the Rotation Time (Sec): is programmed, and this takes some planning.

When the 552 tunes to an HD Radio program, it takes about eight seconds to acquire, buffer and begin delivering the program audio. This is not a consideration for analog FM broadcasts, but if even one HD program is included in the Preset Stations listing, then timing must be set for a minimum of 30 seconds, maybe 60 seconds to be absolutely sure.

There are additional alarm setup considerations when using the StationRotation feature. 552 alarms that have time-on/time-off settings will directly impact the Rotation Time (Sec): setting. See the Alarms discussion beginning on Page 40. The on/off times may be quite different between normal single-station and StationRotation operation.

The Status: display gives a second-by-second countdown of rotation time.

Keep in mind: all the audio outputs will reflect StationRotation operation. Always ask yourself, "Who might be hearing this?"

FM LEVEL METERING

The FM Meters Webpage displays metering for all FM signal measurements.

FM Carrier Modulation

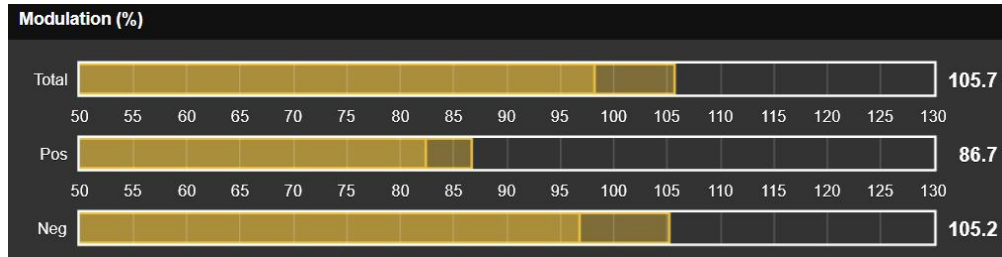

These three bargraphs and the associated numerical readouts to their right give quasi-peak-response measurement of FM carrier deviation. The integration time for this measurement is set by the Mod Response: buttons on the Setup/Radio Webpages screen. The default selection is the fastest, $50\mu\text{s}$ setting, but more ‘forgiving’ selections of $100\mu\text{s}$, $200\mu\text{s}$, $500\mu\text{s}$ and 1ms are also available. We recommend the more conservative default value, but it’s your call.

You should typically see negligible difference between positive and negative deviation readings, reflecting only the asymmetry normally encountered in speech and music waveforms. Consistent discrepancies indicate a possible FM exciter issue.

These total-mod readings should not be affected by accompanying HD Radio “IBOC” (In-Band On-Channel) programs. Great care has been taken in the design of very selective IF filtering to eliminate false indications of FM-overmod at any HD carrier-pair injection ratio. Any observed interaction between analog and digital program channels should certainly prompt further investigation.

Pilot & Subcarriers

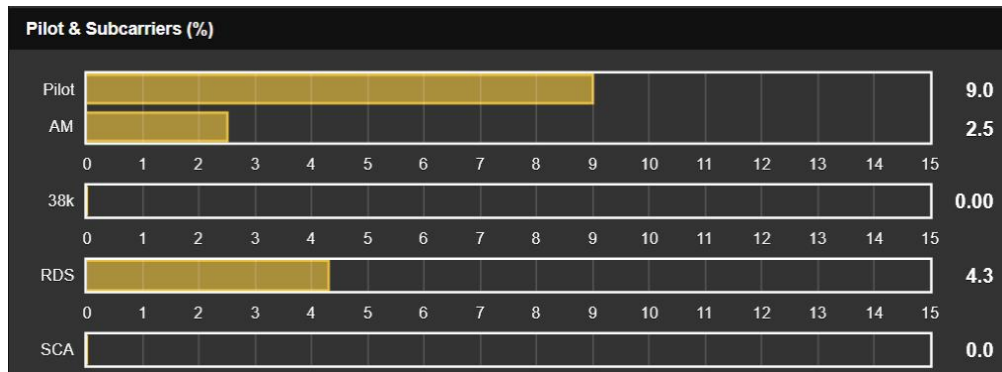

This next screen section leads with the injection level of the 19kHz stereo pilot. On an FM station broadcasting in stereo, Pilot should be a rock-steady reading at about 9.0%. Composite clipping or other nonlinearity in the transmission path can cause this reading to ‘bounce’ to a lesser or greater extent. These level perturbations show up on the accompanying AM bargraph as amplitude modulation of the stereo pilot.

Early FM stereo exciters generated the FM baseband signal using analog multipliers, necessitating an adjustment procedure for nulling the 38kHz carrier component. Today’s stereo-gens don’t need this, yet the 552 gives a readout of 38kHz energy. You shouldn’t see much action on the 38k bar, yet music heavy

in sub-bass may cause this readout to flicker-on occasionally. A steady-state reading or a great deal of bass-associated activity hints at a stereo-gen problem.

The RDS readout gives the injection level of the RadioData sub-carrier at 57kHz. Similar to the stereo pilot, this should be a solid reading at about 5%. Program audio should not modulate the amplitude of this reading at all. Variations in RDS level again suggest transmission path nonlinearity or a problem with the RDS encoder.

When transmitted, the injection level of an SCA subcarrier channel will display at the bottom of this readout group. Associated settings were discussed on Page 20.

Demodulated FM Audio

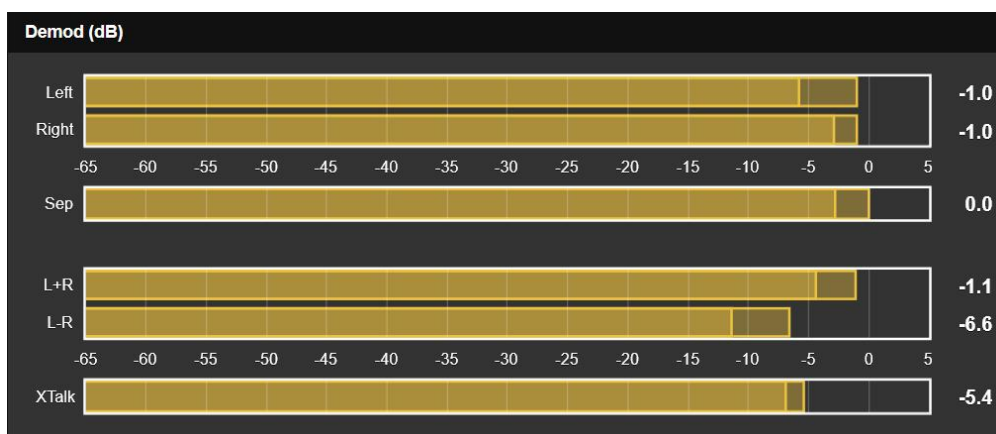

This metering area displays the demodulated FM program audio. Left and Right channel levels have quasi-peak response and a quick fallback for better visualization of instantaneous vs. average program energy. Keep in mind that these meters in no way approximate “VU” ballistics. A floating peak-hold ‘ghost’ hovers briefly above these meters showing the highest peak value recently indicated. This held value is also shown numerically to the right of each meter.

Sep is a measure of stereo separation, based entirely on the level difference between the Left and Right meter readings. This measurement is only valid for steady-state-tone separation tests with one channel driven. It is *not* an indication of stereophony with dynamic (speech and music) program audio.

The L+R stereo sum and L-R stereo difference levels have the same ballistic characteristics and scaling as the Left and Right meters above them. This dynamic sum-and-difference metering gives a better visual representation of stereo separation with program audio. Note that in the example above, Left and Right levels are less than a dB apart, yet the L+R and L-R meters indicate reasonable stereo activity. The fact that Left and Right meters do not factor-in phase differences between the two channels explains this.

XTalk (stereo crosstalk) is similar to the Sep (stereo separation) measurement, but in this case it indicates the level difference

between the L+R and L-R program audio components. Like the Sep readout, it is useful only with tone tests and *not* an indication of crosstalk issues in the program audio.

FM Program Loudness

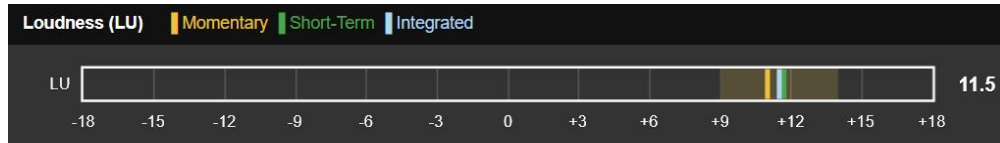

The next subheading deals with the applicable Standard for loudness measurement by the 552 Monitor. The bargraph shown above is for FM loudness measurement, but typical of all ‘LU’ (Loudness Unit) readings.

ITU-R BS.1770 Loudness Measurement

The 552 incorporates a program loudness measurement utility based on (human) ‘perceived loudness’ per the ITU-R BS.1770 Standard. Meter readings under this standard are expressed in “LUs” (Loudness Units), one LU equivalent to 1dB.

‘Zero-LU’ does not conveniently correlate to a specific modulation percentage because of the Standard’s frequency weighting. However, a 1kHz constant tone at the nominal 100% modulation point equates to about +22LU, which will peg the meter.

For our monitoring purposes here, we should probably consider 552 LU measurements “locally-relative,” most useful in comparing loudness between on-site audio programs, market companions, music cuts, processing presets, talent voices, etc.

‘LU’ loudness is displayed as a bargraph, featuring three colored LU indicator bar-segments labeled M, S and I.

- M The yellow segment shows a ‘momentary’ value of loudness, actually the loudness of a 400ms block of audio level refreshed every 100ms. This gives a ‘right now’ loudness reading. The yellow ‘wash’ behind the display represents the level range considered in this calculation, and provides a quick visual of program dynamic range.
- S The green segment is a short-term-integrated value derived from a 3-second block of audio refreshed every second. This yields a readout primarily indicating the loudest sections of program audio.
- I The blue segment is a longer-term integrated measurement and is ‘gated’ to ignore speech pauses and other periods of silence. This is probably the most useful overall, average-program-loudness reading.

This metering method reflects the ‘broadcast’ implementation of the BS.1770 Standard, and is shared in intimate detail in EBU Loudness Standard R-128.

Synchronous and AM Noise

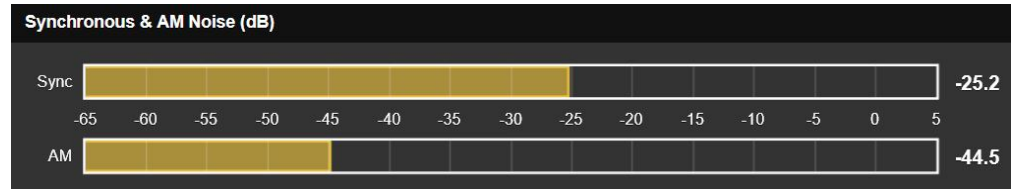

Sync, or 'synchronous' FM noise, generally refers to amplitude modulation of the FM carrier by the FM baseband signal, primarily by the program audio source. If the passband of the transmitter is not frequency-flat, then as the carrier deviates toward the channel frequency extremes the carrier level undergoes amplitude rolloff at the band edges.

AM, or asynchronous, noise is carrier amplitude modulation from any source other than the modulating signal, such as power supply ripple. This AM noise measurement is really useful only with an unmodulated carrier.

Both these noise measurements are expressed in dB relative to 100% amplitude modulation of the FM carrier.

HD LEVEL METERING

HD Levels and Loudness

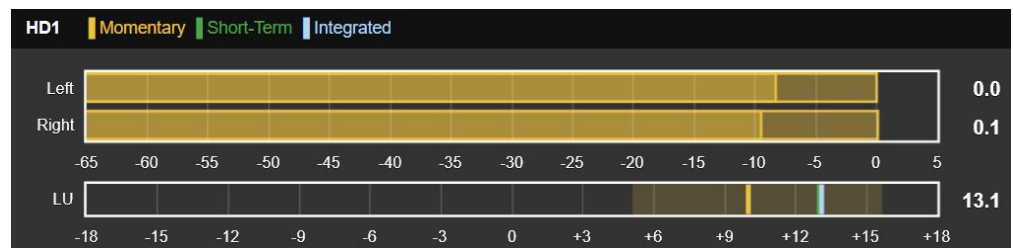

This example readout for the HD1 program level is typical of four such displays on this Webpage screen. The Left and Right meters are quasi-peak program audio bargraphs, with peak-hold and numeric display of the held value as previously explained for FM level metering. The LU display represents loudness per the BS.1770 Standard, also as detailed for FM metering.

The three remaining level displays are labeled per the HD Radio program channel they represent; e.g.: HD2, HD3, etc. If one or more of these displays has not been assigned an HD channel, it will default to an HDA, HDB or HDC callout and show no activity.

Relative HD Program Loudness

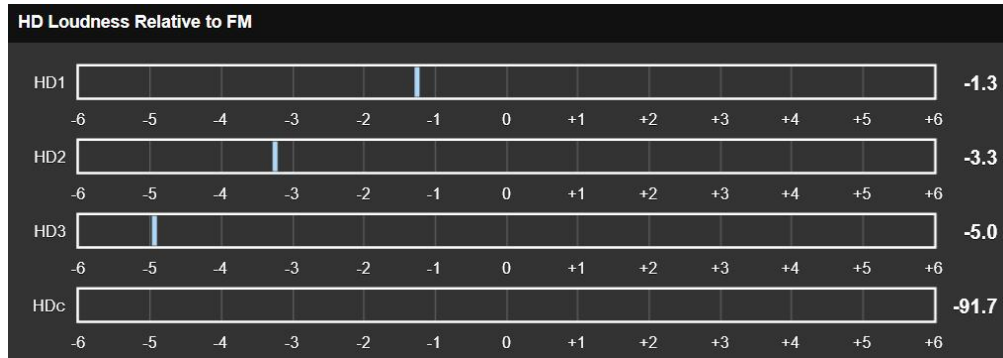

Long-term, 'average' loudness of the station's active HD Radio programs is shown on the HD Loudness Relative to FM display. 'Zero-LU' on this meter scale represents the LU value of the host analog-FM program. Thus both the blue segment and the 'zero' on the scale are continually being updated.

This display is a good indication of the station's loudness consistency. The FM and HD1 programs must be as close as possible to the same loudness for seamless diversity blending and, by the same token, auxiliary programs should be close to FM loudness as a courtesy to the listener as he surfs among your programming options.

SPECTRUM PLOTS

The 552 monitor includes an advanced, high-resolution FFT-based spectrum analyzer that delivers detailed and annotated graphic displays of selected signals. Images are under the Spectrum Plots Webpages menu. Each signal selected for viewing carries its own family of graph setup options below the display.

(Discussion continues on the following page)

The IF Spectrum

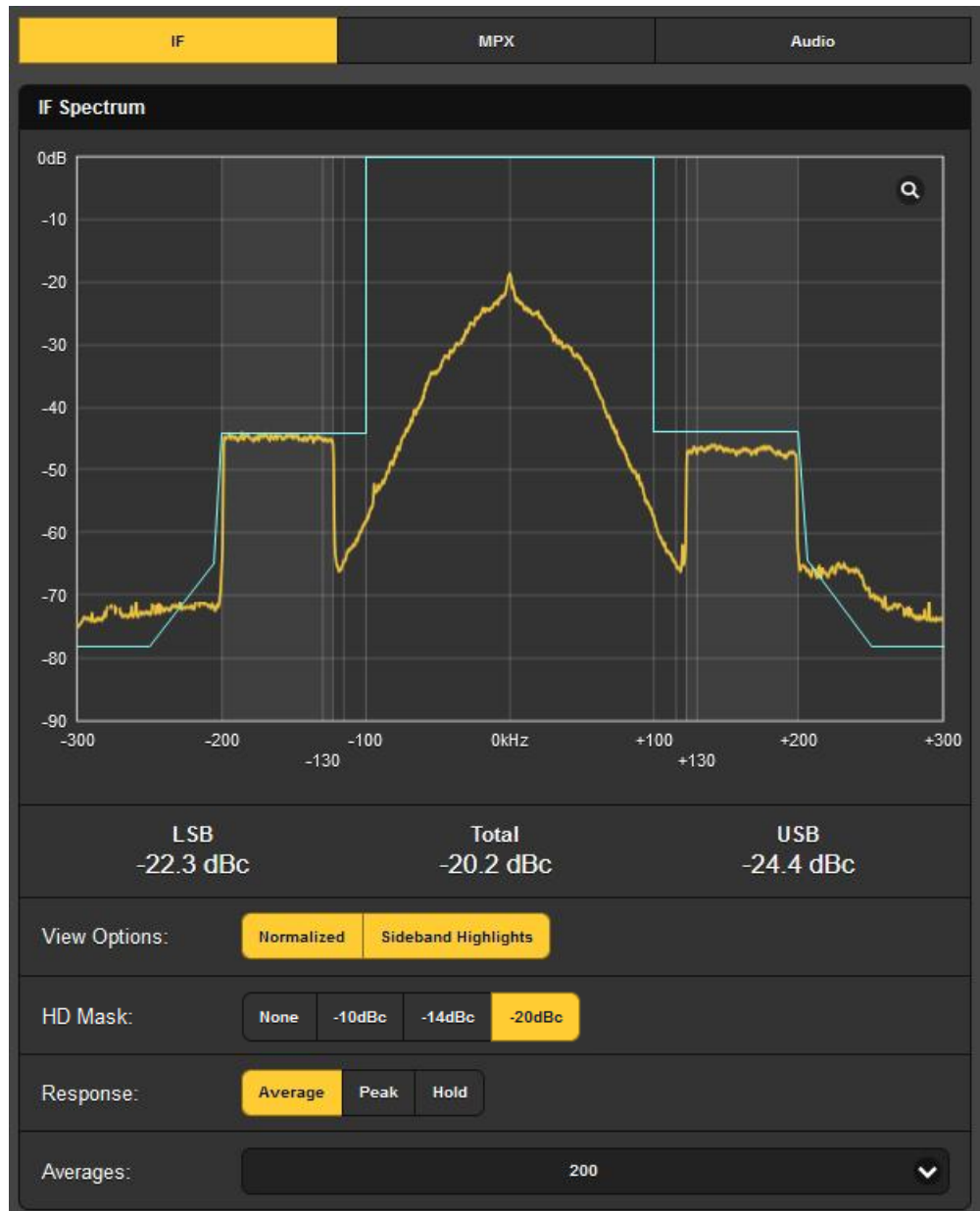

The illustration above is the receiver's IF spectrum. 0kHz represents the carrier frequency of the currently-tuned station.

The display has been Normalized under View Options: to reference 0dB as the unmodulated FM carrier level. HD Mask may be set at the figures shown; the -20dBc choice in this case defines the limits for this station's channel occupancy.

Response: set to Average gives a steady and accurate level readout, Peak shows the peak value of the signal. Hold will accumulate and display the highest peak value until the function is manually reset.

At the bottom, the display Averages: the number of FFT computations selected in the drop-down box. 200 is the factory default, a lower number may be set for a faster (and busier) refresh rate.

The FM Baseband Spectrum

Select MPX at the top of the screen to view the FM baseband spectrum. The L+R 'main' channel, 19kHz stereo pilot, 38kHz DSB 'sub' channel and 57kHz RDS subcarrier are easy to identify, and will in fact be highlighted and the amplitude value shown as you slide your cursor across the screen.

An Average setting of Response: yields a stable and meaningful display, and the default 10 FFT Averages: proves a good compromise for a display that is both dynamic and easy to read. Selecting Peak will reveal peak levels of the spectrum components, and Hold accumulates the highest peak value for as long as it remains selected.



Audio Spectrum Display

Select Audio at the top to present a bi-color spectral display of left and right channel program audio.

View: buttons select FM audio, any of the HD program channels, and you may also view FM/HD1 'split' (mono) audio as an aid in defining diversity delay issues.

Response: and Averages: settings offer the same options described above for the MPX display.

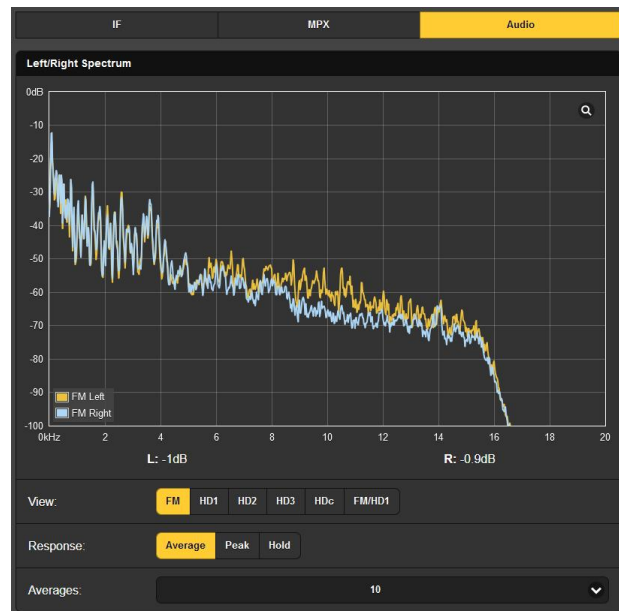

HISTORY PLOTS

The 552 offers plots of nearly all reception and audio parameters viewable over the past minute, or may be selected to show up to a full, 24-hour time-study.

History Screen Basics



This Modulation screen is typical of 552 history-display plots. The buttons at the top choose the specific measurement.

Note the Show: buttons below the screen. When all buttons are activated, by default as pictured, all four parameters are displayed in various colors. If a particular display is confusing, you can easily turn-off those parameters you don't want to see.

The Time Span: selected here is 1 Minute. That means that the 'rolling' display shows the last 60 seconds of activity. For a time study over a longer period, you may select a window that shows up to the last 24 Hours.

Rolling your mouse over this screen drags a cursor over the plot... the vertical white line just to the left of center in the example here. The numerical values directly below the plot show the multiple parameter levels at the cursor position or the current incoming value when the cursor is off-screen. With Time Span: set at an hour or more, actual clock time of the event is shown beside the cursor.

Modulation The Modulation screen used in the example displays both the peak value of carrier deviation in yellow, and a held-peak value in green. In the example, music with very limited dynamics played until about 20 seconds ago, cross-fading to speech. It's interesting that speech seems to perturb both the stereo pilot and RDS subcarrier levels to a small extent; a bit of composite clipping, perhaps?

RF Metrics We could hope that the RF Metrics History Webpage would be the least interesting of the bunch as these are reception metrics that ought to be rock-solid. This station is not one of the strongest in the area, showing some variation in RSSI and RF SNR. The HD Radio parameters do exhibit their expected stability, however, which is good.



Audio History Left- and right-channel program audio levels are shown here in a bi-color display. These are quasi-peak readings that will give an indication of program dynamics also.



The Show: button selects the program channel for display. You may select analog-FM audio or any of the HD Radio channels that accompany it.

Integrated Loudness History This screen plots the loudness level for as many as four HD Radio programs, showing them in separate colors. These readings are integrated (long-term) “LU” loudness measurements.



Note the Loudness options below the plot, selectable between Absolute and Relative to FM. As was discussed previously, LU numbers don’t equate to much on their own. In the interest of loudness consistency between the analog-FM program and, especially, the HD1 channel, these readings are best judged against the FM audio loudness. That’s the function of the Relative to FM selection, for not only do the plots on this

graph follow the loudness of the HD programs, but the ‘zero’ on the LU scale is continually adjusted to the current FM audio loudness. The Absolute selection will show the FM program together with the HDs, but against absolute-LU values

OSCILLOSCOPE

A built-in oscilloscope utility has been included for viewing audio and other waveforms. Vertical sensitivity is scaled and annotated with respect to the 100%-modulation point, and the horizontal timebase auto-adjusts for the most meaningful display of the selected signal.

O-Scope Applications

The primary O-Scope function is to view actual signal waveforms. View: buttons allow selection between MPX (the FM baseband signal), the FM stereo Pilot, the DSB RDS subcarrier, and left and right audio from the FM or any of the HD programs. FM/HD1 displays monaural audio from these two (hopefully) identical program channels in different colors, pictured here. This is a secondary means of assessing time offset between the FM and HD1 programs.



The Pause bar at the bottom of the screen lets you freeze the waveform, and the little magnifying glass in the upper-right corner gives a full-screen display.

Audio XY Display

The ‘scope function can also serve as an XY “stereoscope.” An XY display will indicate both level and phase differences between left and right channels, giving a visual representation of the stereophony of the program and warning of mono-compatibility issues.

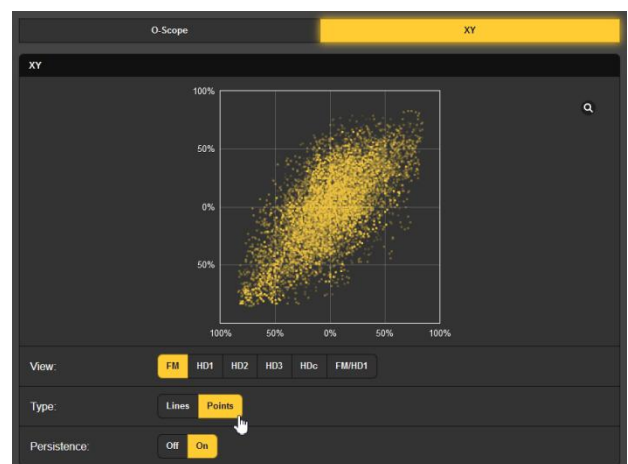

When XY is implemented with a traditional analog oscilloscope, the XY display resembles a ‘connect-the-dots’ image of the so-named chil-

dren’s activity. The 552 and most digital ‘scopes can optionally show either Lines or Points. The Points option presents a more artistic ‘constellation’ as seen in the example. In the example, Points and Persistence were both engaged to also indicate the short-term trend of the stereo image.

FM AND HD1 ALIGNMENT

We’ve discussed how the 552 can correlate *level* differences between the analog-FM and digital HD1 programs, but the HD Radio system requires very tight *time alignment* between the two program channels as well. The 552 is able to correlate this metric and can even display a history of timing offset to aid in tracking-down a diversity-delay problem.

Specs at-a-Glance

The top of the FM/HD1 Alignment Webpage shows the current time and level alignment information in-brief.

| Inst. Alignment | Ave. Alignment | Peak Level | Loudness |
|---|----------------|------------|----------|
| 38 | 38 | +2.8dB | +2.5dB |
| Status | | | |
| HD1 leads FM by 38 samples (0.86ms) - Phase is Normal | | | |

Timing error is shown by the number of 44.1kHz samples. Both Inst. Alignment (instantaneous) and Avg. Alignment (averaged) values are given. You’ll also find the Peak Level of the HD1 audio program, and the HD1 program audio Loudness with respect to the loudness of the analog-FM program.

The Status bar tells whether the HD1 is leading or lagging the FM, and again by how many samples, plus whether the audio Phase between the programs is Normal or Inverted.

Alignment Time Studies

The upper part of the screen plots both the instantaneous and average program delay error against time. A Confidence plot is included, which is a measure of how well correlated the FM and HD1 signals are in terms of both time and level alignment. A negative Confidence measurement indicates out-of-phase audio.

In this image, HD lags FM between 5 and 6 samples. The offset may be presented either in the number of samples or in milliseconds per the Delay Units: setting at the bottom of the screen.

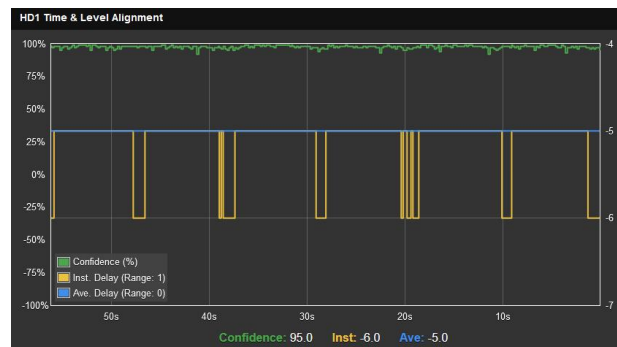

The lower graph plots HD audio Peak; and Loudness; against time, normalized to analog-FM audio parameters. Select which measurements to Show; set Delay Units and Time Span: here too.

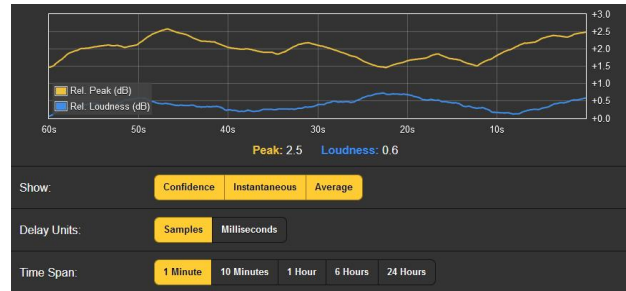

DTAC Operation With the GatesAir FMXi-4g Exciter

The GatesAir FMXi-4g FM exciter incorporates an internal diversity audio delay to provide proper time alignment between the FM and HD1 program audio channels. While this may be set manually for a *static* (fixed) delay of FM program audio, this exciter is further able to maintain *dynamic* time alignment using the current and constantly-updated delay error information provided by the 552 HD Radio Modulation Monitor.

You should first establish that the GatesAir exciter does indeed operate properly with a manually-set fixed delay that keeps the FM and HD Radio programs reasonably synchronized ‘by ear.’

Setup of the 552 for the dynamic function is on the FM/HD1 Alignment Webpage, and also may be performed in much the same manner from the front panel. For this function to work, the FMXi-4g exciter DTAC Mode must be set to Inovonics.

This is a screenshot of the 552 Webpage set-up area in a working system. An explanation of what is shown follows.

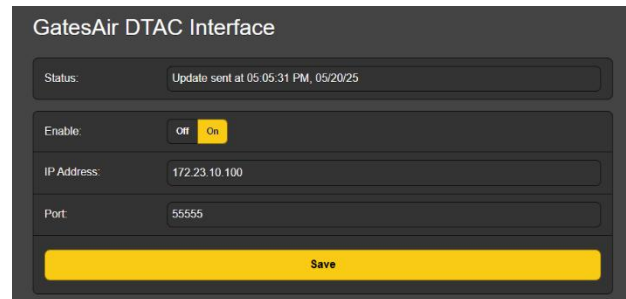

Status: is a short message indicating the current status of the interface. Other messages include Disabled, Enabled (Idle), Unable to connect, Last update failed, and Update Failed (*reason listed*).

Enable: may be set either to Off or On.

IP Address: Enter the IP address of the FMXi-4g exciter here.

Port: This is the port number for communications between the 552 and the FMXi-4g exciter. What you enter here must match the corresponding exciter port number.

Click the Save bar after entering data or making any changes to DTAC Interface settings.

Warnings!



- 1) Operation of the DTAC Interface is valid solely when using the GatesAir FMXi-4g FM exciter.
- 2) DTAC Interface time alignment is valid only for the primary broadcast signal. Monitoring other HD Radio stations in the market (“band surfing”) may cause the FMXi-4g exciter to

apply a grossly incorrect delay. You must manually set Enable: Off when you temporarily wish to monitor other stations in your market! The DTAC Interface is automatically disabled when StationRotation is turned on.

THE BANDSCANNER™ UTILITY

The 552 BandScanner is an annotated RF spectrum analyzer utility that is able to graphically display the entire FM band.

Warnings!



- 1) Band-scanning interrupts all mod-monitor functionality during the scan cycle, as it essentially tunes across the band and collects data from each station in the market. Program audio outputs are muted, and of course scanning will temporarily interrupt all history studies.
- 2) Once the display is presented, clicking on a bar will immediately tune the 552 to that station, which you may, or may not, want to do.

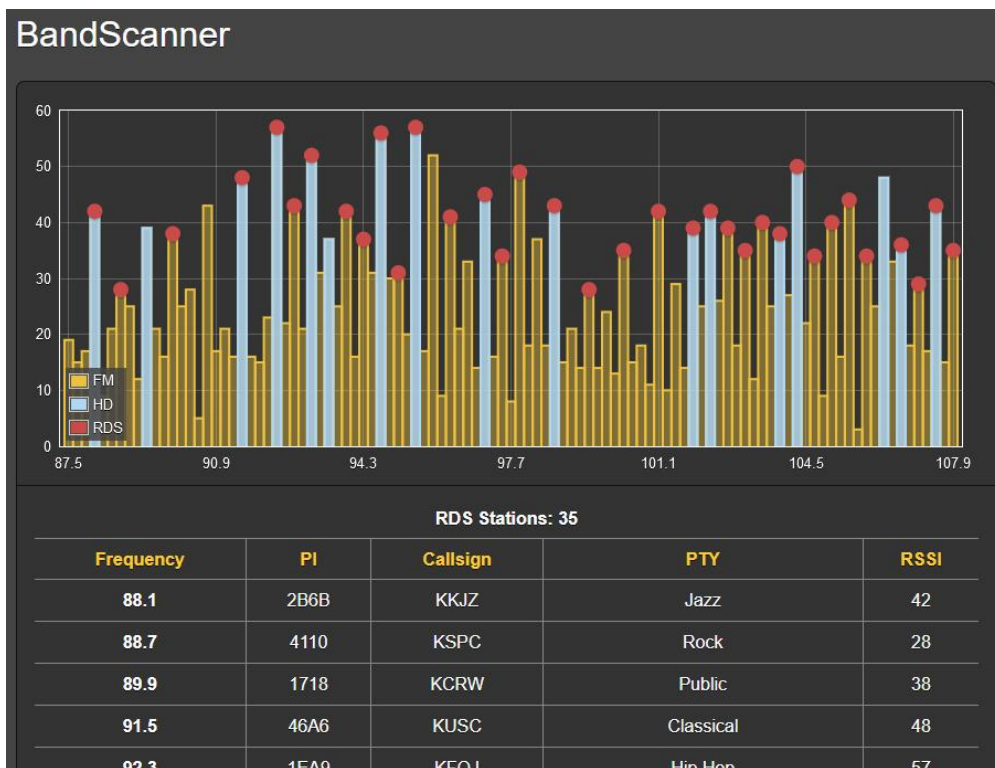

Shown above is an entire FM-band plot of the busy Los Angeles FM market.

BandScanner setup employs the options shown at the bottom of the screen. Three Scan Type: modes are available for selection here. The 552 can scan the band and display only the RSSI level, this is the fastest of the scans. Alternatively it can scan and display both the RSSI + RDS information, which takes a bit longer, and finally it can scan and display RSSI + RDS + HD information, as shown in the example (and is detailed shortly), which requires a time-consuming double-scan of the band.

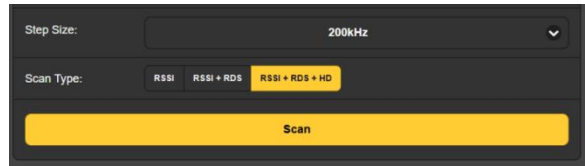

Once the display is presented the 552 returns to how it was set and what it was doing before the scan was initiated. As an added convenience, you can click on any bar shown in the window to immediately tune the 552 to that station.

Start Scanning

To start a band scan, click the Scan bar at the bottom of the page. Step Size: defaults to 200kHz so that the entire FM band is visible; 100kHz steps are also available.

In the example scan above, every FM carrier found is represented by a vertical bar. Bar height indicating signal strength in dBuV per the annotation along the left side. This was an RSSI + RDS + HD scan; had it been done in the simple RSSI mode, all stations would show up as yellow bars.

Bars and Dots

‘Hovering’ over (not clicking on!) a yellow bar shows the Freq: and RSSI: numerical level in a pop-up, as in this inset image at the right.

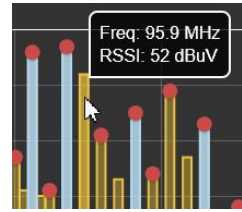

A yellow bar with a red dot indicates that the station carries RDS information. (The red dot appears only when Scan Type: is set to RSSI + RDS or RSSI + RDS + HD.)

Hovering over the red dot will display Freq: and RSSI:, plus the RDS PI: code and its derived Call: letters and the PTY (programming format) of the station as in this second example.

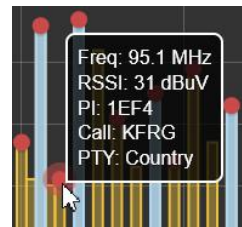

Running a full RSSI + RDS + HD scan additionally shows the HD stations as blue bars, nearly always topped with red dots to indicate RDS information as well.

Hovering over just the blue portion of the bar brings up Freq:, RSSI: and Cd/No: (digital signal quality) stats. Included are which HD Programs: (channels) are being broadcast, and the ‘short’ HD station Name:. To get the RDS info for this station, instead hover over the red dot at the top of the bar as in the second example above.

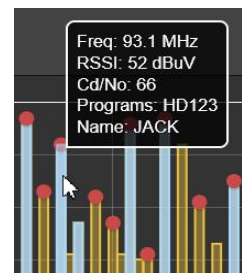

Scanned stations with RDS info are shown in the RDS Stations: list directly below the scan, along with how many RDS stations were found. These are listed in ascending frequency order along with their PI, Callsign, RDS PTY and RSSI values. Click on any station's frequency to immediately tune the 552 to that station and be taken to the Now Playing Webpage.

Below the RDS Stations: list you'll find a separate HD Stations: listing. Information there will include the number of HD stations found, again by ascending Frequency, and which HD Radio Programs are being transmitted. The station short Name, the RSSI reading and the Cd/No figure denoting relative quality of the digital signal are presented there too.

The Cd/No notation is color-coded in this list. A value greater than 57 (solid HD Radio reception) will be green, an orange number is 'iffy,' and a red one generally won't play reliably at all. As with the RDS Stations: listing, clicking on any entry will immediately tune to that station.

THE LISTENER EXPERIENCE

Definition The term 'Listener Experience' encompasses both the metadata text (artist/title, etc.) for both the FM and HD Radio programs, plus the graphic imaging that can optionally accompany each HD Radio channel. Images can include primary station-identification 'Logos,' and music album artwork or program-promotion messages called Artist Experience.

Display Options You'll find analog-FM and all eight HD Radio program buttons at the top of the page. Any of these buttons may be selected, whether the tuned station has those HD programs or not. Selecting them merely creates a display area farther-down on the page for the associated data and images. To save space, select only those buttons that are pertinent to the station and programs you are monitoring.

The topmost display area is labeled FM. The pertinent RDS fields that accompany the analog-FM program are presented here.

HD Radio PAD info and graphics are stacked below the FM RDS data. Once a station is tuned, the Listener Experience material will take a short while to load.

The remaining selectable display option at the top of the screen is for just the HD Radio program channels. Simple | Listener is what the listener sees on his consumer radio. An Advanced | Broadcaster selection will additionally show an archive of previous graphic images. This is illustrated in the left-hand screenshot that follows. The boxed image is album art for the song currently playing. Right of that is album art for previous songs.

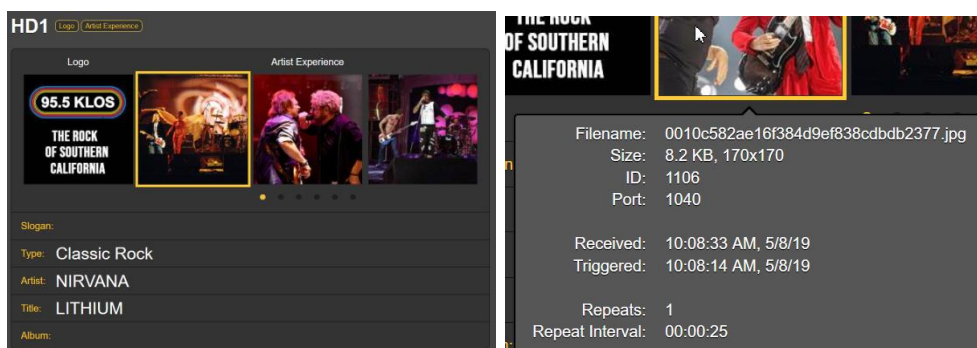

Click the little dots below the Artist Experience images to scroll through previous graphics. Then hover over any image to bring up image specifications as shown in the right-hand screenshot above. These specs define the received image file.

Image Error Reporting

552 diagnostics alert you to an image that does not meet the HD Radio spec. These are images that may not display properly on some radio faceplates. Just hover over the image to bring up the Image Issue(s): info box.

You may click on the first yellow URL link in the box to be taken to an industry Website. There you can upload the off-air image for an instant evaluation and explanation of the problem. In this example case, characters in the image filename did not match the station's HD 'short name.'

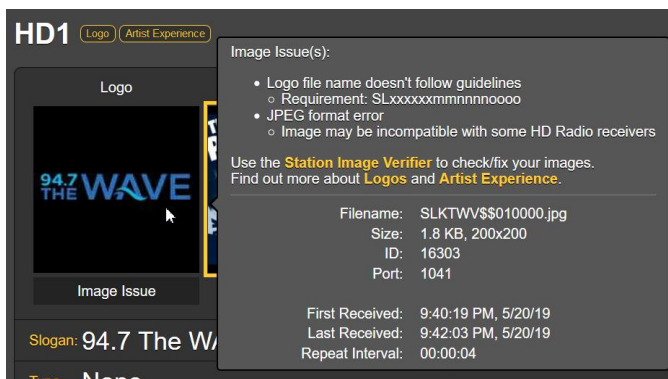

characters in the image filename did not match the station's HD 'short name.'

The other two yellow links bring up technical particulars relating to the specifications for both the station Logo and Artist Experience images. This self-help Website will also direct you to independent sources for assistance in formatting HD Radio images properly.

The Listener Experience display for other HD Radio channels this station carries will be presented in like manner. Remember that any transmitted HD channel must be selected at the top of the page before it will be presented, and time allowed for image downloading.



Additional Image Data

Additional information on Listener Experience Image Data currently being received, including time received, time triggered and packet size, may be found under the Programs heading on the HD Info Webpage.

RDS AND HD METADATA

RDS Info

This 552 Webpage presents a comprehensive display of the RDS information that can accompany analog-FM transmissions.

The upper area of the screen shows the most important blocks of RDS data. These include the static or scrolling PS; the PI Code, either assigned or, in the US and Canada, derived from the Callsign; RadioText and its interactive RT+1 and RT+2 derivatives; plus the various IDs and 'flags' that assist RDS receivers in responding to system commands

Next down the page is an analysis of the RDS Block Error Rate, useful when troubleshooting RDS issues. Below that is a dynamic statistical presentation of all RDS data 'groups,' including the percentage of the RadioData total each group carries.

| RDS Block Error Rate | | | |
|----------------------|--------|-----|----|
| 0.00% | | | |
| 0A | 35.67% | 0B | 0% |
| 1A | 0% | 1B | 0% |
| 2A | 30.32% | 2B | 0% |
| 3A | 5.36% | 3B | 0% |
| 4A | 0.15% | 4B | 0% |
| 5A | 0% | 5B | 0% |
| 6A | 0% | 6B | 0% |
| 7A | 0% | 7B | 0% |
| 8A | 24.97% | 8B | 0% |
| 9A | 0% | 9B | 0% |
| 10A | 0% | 10B | 0% |
| 11A | 0% | 11B | 0% |
| 12A | 3.54% | 12B | 0% |
| 13A | 0% | 13B | 0% |
| 14A | 0% | 14B | 0% |
| 15A | 0% | 15B | 0% |

If the station has an AF List, those Alternative Frequencies are totaled and each is listed. Proprietary Open Data Applications (ODA channels) are also totaled and shown.

| Alternative Frequencies | 3 | Open Data Applications | 2 |
|-------------------------|------|------------------------|---------------------|
| AF1 | 90.7 | 8A | 0xCD46 (RDS-TMC) |
| AF2 | 98.5 | 12A | 0x4BD7 (RadioText+) |
| AF3 | 93.7 | | |

Clicking the Clear/Reset RDS bar at the bottom will indeed clear the registers and begins a new RDS data collection. Reset is automatic when the station is changed.

HD Info

Like its counterpart for RDS, this Webpage presents a comprehensive display of the PAD (Program-Associated Data) information that accompanies HD Radio program channels.

SIS (Station Information Service) includes station-identification and other data that each HD station must provide. Even the transmit-



ter location is pinpointed with GPS coordinates; you may even click-on these to bring up a Google Maps image of the transmitter site.

Miscellaneous includes additional station specifics on coding and transmission, as well as showing the particulars on any Emergency Alert that is being transmitted at the moment.

The Programs area of the screen supplies information pertinent to the programming of each HD Radio channel being transmitted. Current program station logos and album art for all HD channels are presented at the top of this display area, and then each HD channel is detailed below.

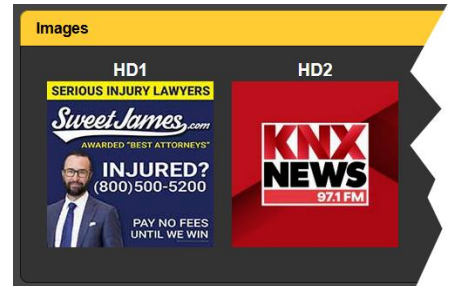

Each individual HD channel presentation echoes the primary program-associated data provided on the Listener Experience page, but in addition flags whether Logo and Artist Experience information is being received, and gives additional statistical information for HD Radio images.

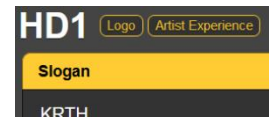
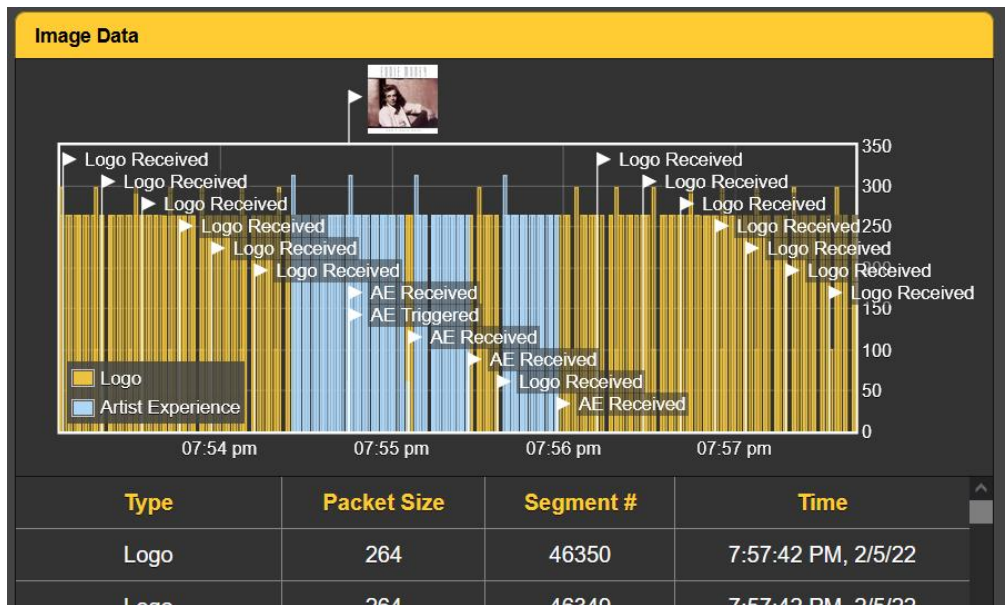

Image Data are shown as-received in a rolling real-time plot of the most recent data packets. The time period automatically varies with the data as the plot is capable of displaying only a certain number of events.



A further refinement of Image Data in tabular form appears below the rolling graphic. The tabulation assigns absolute values to Type, Packet Size, Segment # and Time. This tabulation 'rolls' as well, showing the same events as the timeline graphic. Information includes the times that images are received and cleared, and verifies the repeat interval. You may 'drill down'

through several minutes of this information that is useful in troubleshooting HD Radio image display problems.

ALARMS

Alarm Status The 552 provides alarms for signal or program-related error conditions. Alarm Status indicator ‘lamps’ head the Alarms Webpage, and also appear on the Now Playing Webpage.

Set the Clock! Alarms are logged with time and duration stamps. Be sure to select the time zone and ensure that the 552 is sync’d with Internet time. This is explained shortly.

Important!



When an alarm or multiple alarms have been set with a station tuned-in, those settings will apply to any station *manually* tuned afterward; that is, tuned without using station-memory ‘pushbuttons.’ However, individual station memories are able to inherit alarm and other settings as Preset Stations or ‘virtual pushbuttons’ (see Page19).

To associate any alarm setting *changes* (updates) while the station is tuned-in, you must navigate to the Now Playing Webpage and Save Changes under the Tuner heading so that those alarm updates will then pertain only to that station. This Save Changes procedure must be completed immediately after programming or changing alarm settings, before the 552 is retuned to another frequency.

Any of the alarms is also able to initiate email or SMS/text messages to selected personnel. These alarms will also be logged for later analysis.

Up to ten alarm conditions may be assigned to rear-panel GPO ‘tally’ outputs to interface with remote-control equipment or local lights and sirens. This is explained in the Setup Webpage discussion.

Alarm conditions must first be set-up as described in the remainder of this section. Following that, the email/SMS messaging and rear-panel GPO tallies may be programmed. These procedures will be described in the Setup and Email Webpage discussions, respectively.

NOTE: Do please read the following discussions in their entirety. A setup explained for one alarm that is common (or quite similar) to the setup of others may not be explained in full detail a second time. Click any + under Alarm Settings to open the setup boxes.

Overmod

Alarm: On ‘arms’ the function in this and all similar alarms to be discussed. If the alarm is turned Off, there will be no indicator on the Now Playing or Alarm Webpages, no closure at a rear-panel GPO terminal, nor will the 552 send SMS/text or email alerts to station personnel or log the alarm. *This applies to all alarms.*

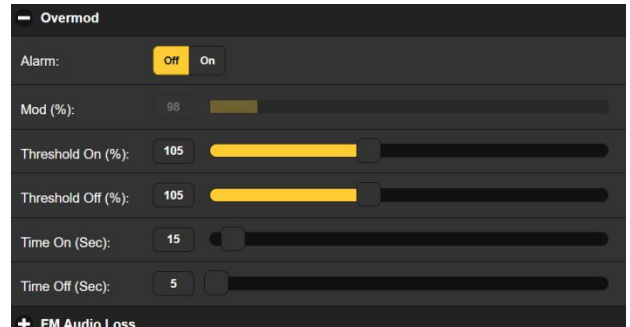

Mod (%): displays the total modulation level of the off-air program being received. This is ‘grayed-out’ because there is no adjustment in this case. Levels displayed in these grayed-out meters make alarm setup decisions easier.

Threshold On (%): is the set point that total-mod must reach to trigger an alarm. Moreover, the total-mod level must remain at or above this set point for the number of seconds programmed for the Time On (Sec): slider.

The alarm will reset (clear) when total-mod drops to a Threshold Off (%): value specified by this slider, and remains at or below that point for the number of seconds set by the Time Off (Sec): slider.

In the example illustrated, total mod must reach 105% and stay at or above that figure for 15 seconds before an alarm is triggered. Then when total mod drops, it must stay below 105% for 5 seconds for the alarm to reset.

In this case we have determined 105% as a ‘drop-dead’ alarm figure, with a full 15-second blast of overmod as an alarm condition. This example alarm was set without hysteresis, but others may require this feature, as we’ll see next.

‘Hysteresis’ Type Alarms

This discussion relates to a number of alarms, not necessarily related, but with very similar setup options. This will pertain to the following: FM Audio Loss, Low Signal, HD1 Audio Loss, HDA Audio Loss, HDB Audio Loss and HDC Audio Loss.

FM Audio Loss

Using FM Audio Loss as an example for this group, Alarm: must of course be set On to function. The grayed-out Level (dB): meter shows the current program audio level for this channel.

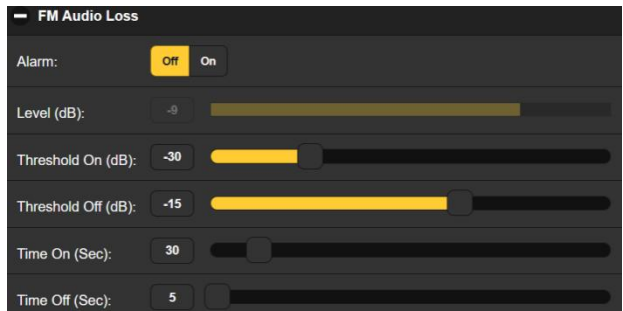

In this case we’re looking for a low-level audio condition, so the Threshold On (dB): setting of -30 is what the program level has to

drop to, and stay below -30 , for the Time On (Sec.) interval of 30 seconds.

For the alarm to reset/clear, program audio must reach and remain above the Threshold Off (dB): figure of -15 for the Time Off period of 5 seconds.

This same logic applies to the other alarms in this 'hysteresis' group. Just remember that it's both level *and* time settings that will trigger and reset an alarm.

Low Signal Mute

The Low Signal alarm has one feature that the others in this group don't. Mute: may be set On to mute program audio when the alarm is active (triggered and not yet reset/cleared). HD channels will mute themselves, but FM audio will naturally hiss like a nest of snakes when the carrier disappears. We recommend setting Mute: to On, for not only will it obviate a blast of noise, but also will ensure that the FM Audio Loss alarm will trigger if the station leaves the air.

Pilot Loss

This alarm indicates loss of the FM stereo pilot, a rare transmitter plant failure mode but still an included alarm. There are no threshold settings, just Time On (Sec): and Time Off (Sec):.

Multipath

Multipath effects are more usually associated with reception problems rather than transmission faults, although an audio processor or stereo-gen fault can appear as excessive multipath. Again, the current Multipath (%): figure is shown grayed-out, and threshold and time settings can be programmed to trigger an alarm for an undue condition.

RDS Alarms

There are two Off or On settings for RDS errors. Turning RDS Loss: On delivers an alarm when the RDS subcarrier simply goes missing. Setting PI Error: On gives an alarm when RDS is received with a PI code mismatch.

RDS data contains a PI code unique to the station. A PI mismatch can signal a translator 'hijacking' by a radio hooligan, or the less sinister condition of the expected signal going off-air and a distant on-channel broadcast received in its place.

To enable the PI mismatch function, enter the station's true PI code in the PI Code:

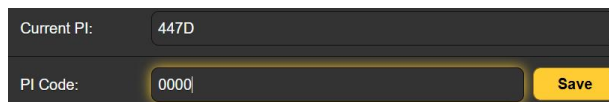

The image shows a dark-themed control panel with two rows of text. The first row is 'Current PI: 447D'. The second row is 'PI Code: 0000' followed by a yellow 'Save' button.

box. The code being received at the moment is shown as the Current PI:. If that's indeed your station, you can enter that hex value as shown, and then click Save.

There are no threshold settings for RDS alarms, and both sub-carrier loss and PI mismatch share the same Time On (Sec): and Time Off (Sec): settings. Otherwise these work the same way as alarms already discussed.

RDS RadioText Not Updated

When a playout system ‘sticks’ while sending RDS RadioText, it can cause problems, not only the display of RadioText, but by upsetting the attendant RT+ functions as well.

Turn the Alarm: On and set a Time On (Min): at a nominal figure of 20 minutes or so to alert personnel to a ‘stuck’ RadioText field.

RDS CT Out of Range

This alarm function compares local Internet time with the transmitted RDS time used to set listeners’ car radio clocks. This is not a nit-picking comparison; rather, it’s a safeguard against transmitting a false time and really upsetting listeners. Of course you’ll want to verify that your 552 is indeed set to, and in-sync with, Internet time before using this function.

There is only a Threshold (Min): setting, the alarm simply triggers (or resets) when the mismatch exceeds (or falls back below) the set number of offset minutes.

RDS TMC Not Received

The Traffic Message Channel provides traffic congestion updates to GPS navigation systems in the vicinity of the host FM station. Information is updated constantly, so 8A RDS group activity falling below expected usage can trigger an alarm.

The grayed-out TMC Groups (%): indicator shows the current level of activity, which in practice can easily reach the 25% pegged-out maximum. Based on typical group usage, program appropriate Threshold (%):, Time On (Sec): and Time Off (Sec): settings.

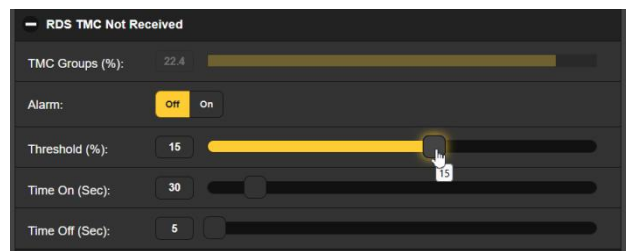

SCA Loss

Stations running an SCA subcarrier first need to set up the proper measurement parameters on the Tuner menu (Page 20). Only then should this alarm be used. Current SCA Injection (%): is shown so that threshold and timing sliders may be set appropriately. Note that this alarm signals loss of the subcarrier only, not loss of SCA audio.

HD Audio Loss

There are four independent audio-loss alarms for HD1 and the three HD channels assigned to HDA, HDB and HDC. Setup of these alarms is identical to that for FM Audio Loss discussed earlier.

HD Loss

This alarm flags the loss of general HD signal acquisition, more indicative of an exporter/importer/exciter fault than a concurrent HD program audio loss alarm. Other than what triggers it, this works just like the Pilot Loss alarm.

HD Program Loss

Similar to the HD Loss alarm, HD Program Loss flags the loss of individual HD channels, again loss of the complete program channel, not just audio silence. The Alarm: button array selects the channels to be monitored for loss; Time On (sec): and Time Off (sec): settings apply to any of the channels selected.

**HD Power
Out of Range**

The power level of the HD Radio signal is expressed in dBc, or dB below the resting level of the host FM carrier. Subject to the station license, levels can be -20dBc, -14dBc or -10dBc.

The HD Power Out of Range alarm is set with the Limits (dBc): 'window' slider, an alternate means of programming a range of min/max values. The slider has two buttons, the upper one set for the highest dBc value of acceptable power, the lower one for the lowest, -19 and -21, respectively in this example. The current HD Power (dBc): reading of -20.1 here is shown just above the slider. The usual Time On (sec): and Time Off (sec): settings apply for this alarm too. With this setup the alarm will trigger if the level varies outside the specified range for 30 seconds, and will reset itself when it returns within the stated range for 30 seconds.

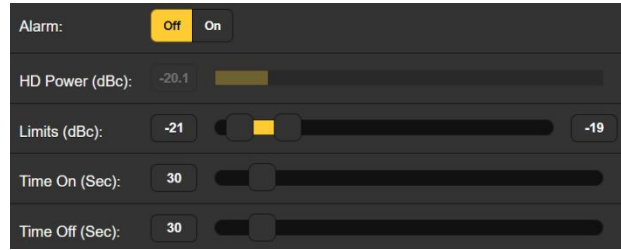

**FM/HD1
Alignment
Out of Range**

You can set this alarm to let you know when your FM and HD1 programs are out of time sync. In this example, Alignment (smp): tells us that currently the HD1 program lags the FM audio by just 2 samples.

At the current (default) setting, an alarm is triggered if this figure reaches ± 50 samples and remains beyond that figure for 30 seconds. For the alarm to reset, the HD1 program needs to wander back to within 5 samples of, and hold below an error of 5 samples for a full 30 seconds

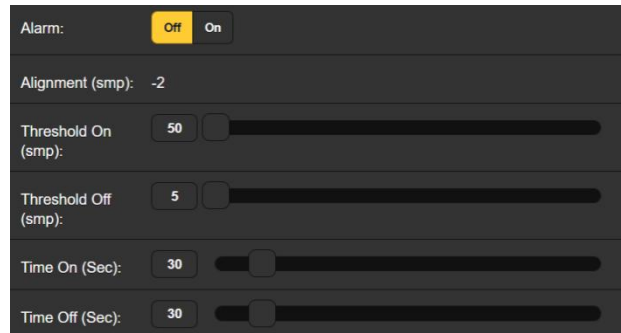

**HD PSD
Not Updated**

This alarm issues an alert when HD Radio Program Service Data (PSD) is not updated within an expected timeframe.

Any or all HD programs may be activated to alarm when their respective Artist: and/or Title: and/or Album: field(s) do not receive an update within the number of minutes specified in the Time On (Min): period. Click on the HD channel button under any category to arm that function for this common alarm; click again to deselect.

**HD Logo
Not Received**

The 552 can initiate an alarm when the station logo image is not received or updated in timely fashion. This alarm is otherwise similar to the HD PSD Not Updated alarm, in that any or all HD channels may be selected to trigger an alarm. The programmed Time On (Min): applies to all channels selected.

HD Artist Experience Not Updated

This alarm parallels the HD Logo alarm just described, except that it relates to Artist Experience graphics instead of the station Logos.

HD Image Issues

As explained on Page 37, the 552 has built-in diagnostics to indicate that Logo and Artist Experience graphics may not meet the HD Radio image specification. When this Alarm: is turned On, you'll be notified of an image problem and the notation will be logged. The drop-down box for this alarm gives detailed data on what might be wrong with the image with links for help.

HD TMC Not Received

This alarm is similar in function to RDS TMC Not Received discussed above, but has no setting related to expected activity. Rather, it is triggered when the associated data services necessary for traffic are missing or when no traffic data is received.

HD Emergency Alerts

This alarm function indicates traffic, weather and other emergency alerts and messaging. You can program this to send an email either for the start and end of a given event, or a separate email for each repeat of the alert. Setup for sending emails or text messages to station personnel is explained on Page 52.

Alarm Logging

In addition to local displays and SMS and email alerts to signal and programming faults, alarm data are logged and stored. You can click + View Alarm Log at the bottom of the page for a display of all alarms in order of time and date.

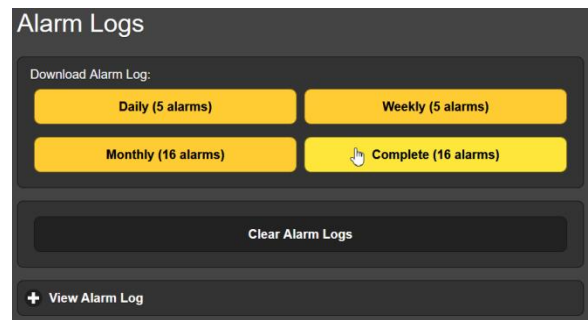

The log holds data on the nature of the Alarm, which monitored Station it pertains to (important when the StationRotation feature is active), the Time and Date received, and its Duration.

| Alarm | Station | Time | Date | Duration |
|------------------------|----------|-------------|----------|----------|
| Audio back | 94.7 HD1 | 12:47:06 PM | 05/13/19 | 00:04:38 |
| PI normal | 94.7 HD1 | 12:46:31 PM | 05/13/19 | 00:04:01 |
| Audio loss | 94.7 HD1 | 12:42:28 PM | 05/13/19 | |
| PI error | 94.7 HD1 | 12:42:30 PM | 05/13/19 | |
| HD4 Artist not updated | 94.7 HD1 | 10:12:27 AM | 05/13/19 | |
| PI error | 94.7 HD1 | 02:38:28 PM | 05/10/19 | |

You may View Alarm Log on your screen and even filter the results by overtyping Filter alarms... with a search term from an appropriate column.

You may also download the Alarm Logs for Daily, Weekly, Monthly or Complete (all alarms) time periods. The number of alarms received for these time periods is also shown here. Downloads are saved to your computer as small .csv text files.

The Alarm Log will continue to accumulate entries indefinitely. Clear it completely at any time by clicking the Clear Alarm Logs bar. This will delete all entries. You'll be asked to confirm this

action, and you might decide to download the Complete log of all alarms first to be on the safe side.

SETUP

552 setup is actually accomplished by entries on a number of the Webpages. Items specific to the Setup page will be discussed in order here.

Radio Settings 75 μ s is the default De-Emphasis; but may be changed to 50 μ s, for Europe and some other regions outside North America, or to None as might be required for test purposes.

RDS/RBDS: sets the mode for RadioData to the North American RBDS or the European RDS standard.

Mod Response: refers to signal integration for the quasi-peak readout of FM carrier modulation. An FCC specification for this measurement no longer exists, but it is our recommendation to err (if necessary) on the side of caution and choose the fastest, 50 μ s setting.

A programmable IF Filter: attenuates demodulated FM components beyond the 100kHz limit of the composite/MPX pass-band. This is especially important in ensuring an accurate FM total-mod reading in the presence of the HD Radio digital carrier pair, which is transmitted independently, but can still interfere with analog measurements. Filter choices refer to the HD Radio transmission mode; Auto is our recommended choice.

Loudness Window (Sec) refers to the long-term-integrated LU loudness measurement readings for all LU-loudness metering, which is the light-blue bar on these meters. The range is adjustable by the slider between 30 and 120 seconds. The BS.1770 Standard is a bit nebulous with regard to this integration; we recommend the default value of 120 seconds.

MPX Output The rear-panel MPX OUT BNC connector can deliver either the FM-baseband MPX signal or the 19kHz stereo Pilot Sync tone. The Level (V_{PP}): of the waveform may be adjusted between 1 and 6 volts peak-to-peak in 10mV increments.

Assignable Audio Outputs The analog left/right and AES-digital 'assignable' line outputs are independently programmed and adjusted for output levels here, both in the same manner.

The choice in each case is audio from FM, from HD1, or from any of four HD programs selected on the Now Playing Webpage as described on Page 20. 'Split Mode' FM/HD1 audio is another choice for time-alignment confirmation by ear. Selected channels will show up here as HD2, HD3, etc., or as HDC (for example) if that selection has been set to None.

You may set the Assignable Analog Output Level (dBu): slider anywhere between -15 and +15, and the Assignable Digital Output Lev-

| | |
|--------------------------------|--|
| | el (dBFS): slider between -30 and 0. Other information regarding these outputs is found on Page 11. |
| Dante/AoIP Streams | This section of the Setup Webpage adjusts only the program line levels of the five simultaneous Dante/AoIP output streams on the rear-panel RJ45 AoIP Port. As with other digital outputs, the Level (dBFS): may be set between -30 and 0. Other Dante settings are addressed in a separate subsection shortly. |
| Other Streaming Options | The 552 offers HTTP/Icecast Streams for general ‘tune-in’ listening and as independent UDP streams that allow the 552 to send raw compressed audio to a specific IP address and port. Both modes are available concurrently and are set-up under the Stream category of Dedicated Outputs on the Setup Webpage. (The little loudspeaker icon at the top of each 552 Webpage makes use of HTTP/Icecast streaming.) |
| HTTP/Icecast Setup | <p>The five HTTP/Icecast streams are accessed using the IP address (and 552 port assignment if required) followed by a slash and which stream you wish to hear. To listen to the FM audio program examples might be: http://10.0.0.19/stream0 or http://50.79.39.149:552/stream0. /stream1 would bring up HD1 audio, /stream2 the program assigned to HDA, /stream3 for HDB and /stream4 for HDC.</p> <p>The streaming Codec: is fixed to HE-AACv2 standard, at a streaming Bitrate (kbps): that defaults to 64 (kbps), although it can be manually reset all the way down to 18 kbps for really poor network conditions. The streaming Sample Rate: may also be changed, from the digital-radio broadcast plant default of 44.1kHz to 48kHz.</p> <p>For the general-listening HTTP/Icecast Stream, a useful 552 feature is the ability to add-in a fixed Audio Latency (Sec): delay to the inevitable delay inherent in transport. This provides more data “ready to go” upon connection, in turn helping the client’s buffer to fill and playback to start faster.</p> <p>Although the 552 can accommodate as many as 10 simultaneous Web listeners, this number can be truncated in the interest of better streaming service to fewer authorized listeners. Set the Max Listeners: slider anywhere between 0 and 10.</p> |
| UDP Streaming | The 552 can send up to five, independent program audio streams over UDP to any IP Address: with a designated Port:.. Enable: must be set to On, of course, and a proper Transport: mode selected; check with the receiving end to confirm Transport:, IP Address: and Port: in each case. |
| Save the Settings! | Once streaming settings have been set-up, or later modified, settings must be saved by clicking the Save bar at the bottom of the Webpage. This reset of the streaming utility will disconnect any current Web listeners, who then must then log back on. |

General Purpose Outputs

The rear-panel General Purpose Outputs (GPOs) serve as ‘tallies’ for up to ten 552 signal and program fault alarms.

Each output is numbered in accordance with the numbers above the barrier strip on the rear panel. The alarm associated with each connection is listed as well, along with whether or not that alarm has been set to active on the Alarms Webpage.

Clicking the + opens the alarm options window. Here you specify Polarity:, whether you want an Active Ground (ground) or Active Open (open-circuit condition) when the alarm is triggered.

Although the Type: of alarm has been factory-preset to the more important faults, a pull-down menu lets you reassign that alarm to any of the others, although some of the alarms have been ‘bunched’ in the Type grouping.

Alarms are covered under their own subheading and will be discussed individually. See Page 12 for wiring information on the GPO tally outputs.

In this example, Output 1 has been programmed for Polarity: to deliver an Active Ground to GPO terminal 1 for an alarm Type: of Audio Loss. It could as easily have been set to deliver ground on that terminal all the time, and then go Active Open (ungrounded) when the alarm is received.

The Status: line in this example shows Output 1 is Inactive; that is, the assigned Audio Loss alarm has not been tripped.

Any of the alarm conditions could have been assigned here in the Type: field. Choose those that are most important to you and assign them to the GPOs.

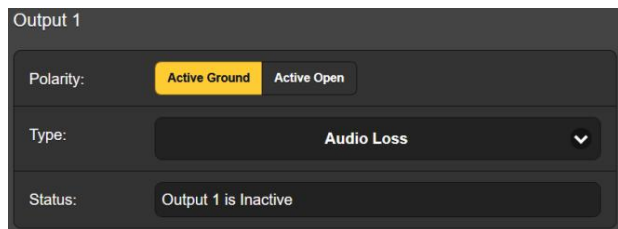
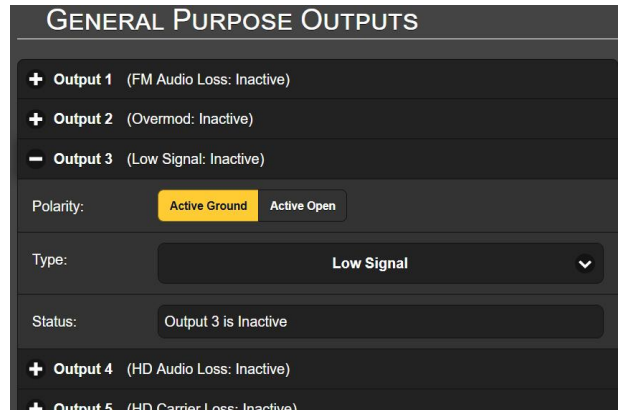

NETWORK SETUP AND INTERNET ACCESS

If Web interface pages are appearing on your screen, what follows must already have been addressed.

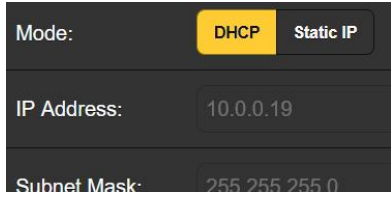
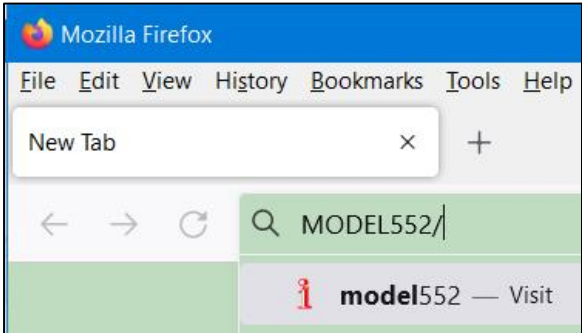
- IP Setup** With Mode: set to DHCP, your router automatically assigns the 552 an IP Address: and will populate the four associated fields, although they will be 'grayed-out' and you'll not be able to edit the data in those fields. However, if Mode: is changed to Static IP, then you must make the appropriate entries in all four fields.
- 
- Assigning a Hostname** You may change the default name MODEL552 to something else, either to personalize the equipment name or to differentiate one 552 monitor from another one on the same network.
- Overtyping the default Hostname: without using spaces. Be sure to click the Save bar at the bottom once all entries are finalized.
- HTTP Port** The default HTTP Port: 80 is common when accessing networked equipment like the 552 on a local network (LAN). You may change this to another port assignment as may be required under certain circumstances. Remember to Save your new setting.
- MAC Address** The MAC Address: (Media Access Code) for your particular 552 is factory-assigned and cannot be changed. You may wish to make note of your unit's MAC Address: to help identify it on your network.
- Link Speed** Link Speed: is an indication of connection status and the expected bitrate between your 552 and the local network (LAN).
- Addressing the 552** Under the Windows operating system, you may access 552 Webpages on a common LAN by typing its Hostname and a forward-slash into the browser address bar as shown here. This entry is not case-sensitive. Non-Windows browsers may require you to enter the complete IP address of the unit, which you can always find by navigating to the front-panel Network menu.
- 
- Incoming Internet Access** To access the 552 from the Internet, the unit must be assigned a static IP address. If your router makes DHCP assignments for other equipment on the network, simply assign a static IP that is outside the router's DHCP range. This should be an easy matter with the aid of the router's Help utility.
- You also need to open a specific port for the 552 on the network router. Within the router's Port Forwarding utility you

will be able to enter the static IP address for your unit (Internal IP), followed by a colon and a port number. The port number may be any number in the router's range.

If your Internet Service Provider (ISP) assigns you a static IP address, then it is a simple matter to address the 552 from anywhere. Just type the IP address and port number into your browser as pictured here.

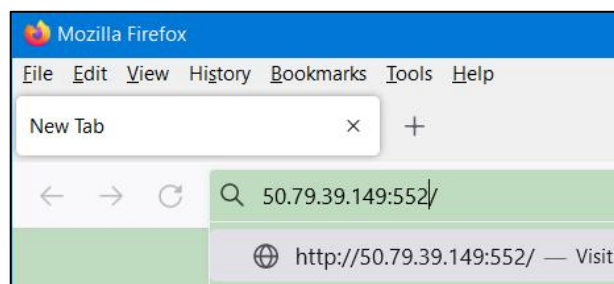

But if your ISP issues a *dynamic* IP, which is more often the case, this mandates 'Dynamic DNS' operation, using the services of an IP-forwarding provider. This is an operation you should entrust to your IT department; explanations and instructions are available from multiple Web resources.

DANTE® AND AoIP STREAMING

The term Dante® refers to networking technology developed by the Australian firm, Audinate Pty. Ltd. It enables simple connection with other Dante-equipped devices, and gives AES67 AoIP (Audio over Internet Protocol) compliance and interoperability among a wide range of pro-AV products. It is generally also compatible with proprietary systems from independent manufacturers of AoIP-enabled equipment.

IP Settings Mode

The Dante-based AoIP utility of the 552 is quite similar to the product's general networking function. Like the LAN connection, the independent AoIP connection may accept IP address assignments in either a DHCP or Static IP assignment Mode. Static IP operation requires manual entries into the four fields that are grayed-out when your router makes DHCP assignments.

AES67 Enable

The Dante utility is able to AoIP-stream audio at two sample rates; this setting is discussed shortly. The AES67 Standard specifies a 48kHz sample rate, but 44.1kHz is a rate with wide use in radio and television broadcasting and is the default rate for the 552. With AES67 Enable: set to Enabled, streaming is forced to a 48kHz sample rate.

The AoIP MAC Address

The MAC address: for AoIP streaming is not the same as the one for general Web interactivity of the 552; these are two independent network connections. Like the rear-panel LAN PORT, the AoIP PORT has a unique Mac Address: that is factory-assigned and cannot be changed.

| | |
|-----------------------------|---|
| Link Speed | <p>Link Speed: is a readout showing connection status and the expected networking rate for the AoIP connection.</p> <p>Remember to click on the Save bar after making or changing Dante setup parameters.</p> |
| Audio Format | <p>Encoding: refers to the word length for the PCM-encoded digital audio to be sent as AoIP. PCM 16 , PCM 24 and PCM 32 refer to word length for Dante AoIP flows; AES67 flows are locked to PCM 24 regardless of this setting.</p> <p>Sample Rate: is forced to 48kHz for AES67 streaming, but 44.1kHz is the 552 default rate unless AES Enable: has been set to Enable.</p> |
| Transmit Flows | <p>The AoIP utility can specify multiple destinations for the audio stream. These are set in the Dante Controller. Flows are individual audio channels, such as FM left, FM right, HD1 left, HD1 right, etc. Thus there are ten Flows for the five, simultaneously-available program channel outputs. Any flow or combination of flows can be directed to destinations, for a total of 16; any specific flow can be sent to more than one recipient.</p> |
| The Dante Controller | <p>The Dante Controller is a free software utility available from Audinate, Dante's developer. It is an essential software means of finding, setting-up and controlling Dante-enabled devices on your network. It may be downloaded for operation under either Windows or Macintosh operating systems from the following link.</p> <p>https://www.audinate.com/products/software/dante-controller</p> |

SNMP OPERATION

| | |
|-----------------|--|
| Overview | <p>SNMP (Simple Network Management Protocol) allows other equipment on the same Local Area Network (LAN) to communicate directly with your 552, and for your unit to send alarms and supplementary information to other equipment on the network.</p> <p>The 552 will interface directly with a network controller, technically known as the SNMP 'Manager.' The 552 has an embedded ASCII text file called a Management Information Base, or MIB. In setting up for SNMP operation, the MIB file will have to be downloaded from your unit through the Web interface and uploaded to the SNMP Manager. This is detailed later-on.</p> |
| Mode | <p>The SNMP submenu default Mode: setting is Disabled, which inhibits communication between the 552 and the SNMP Manager.</p> <p>Changing Mode: to Read Only allows the 552 to be interrogated by the SNMP Manager, so that programmed setup parameters, alarms, etc. can be integrated with other equipment on the network.</p> |

Setting the Mode: to Read & Write allows the SNMP Manager to send commands to your unit for remote control of all functions.

Security SNMP 'Communities' serve as passwords for this function. In the Read Community: and Write Community: fields, overtype the factory default public and private entries, entering text that is specific to the read/write strings on your SNMP Manager monitoring device. You must do a Save after entering your text.

Ports The default SNMP Ports, SNMP Port: 161 and Trap Port: 162, are customary for a majority of SNMP operations. Overtyping these defaults to change them as required and do a Save.

Trap Destinations When the 552 *initiates* an alarm, rather than being *queried* or *polled* for one, that alarm is known as a 'trap.' Three local network IP addresses may be entered in the Trap Destination 1:, 2:, and 3: fields, each corresponding to other devices on the LAN that require alarm notifications. Overtyping the defaults with valid IP addresses of other equipment and do a Save.

The MIB File The MIB File is a small text file required by the SNMP Manager. Click: Download MIB to save this file using the usual Windows methods. The MIB file is in plain text with a .mib extension, and may be read with Windows Notepad.

NOTE: This is an abbreviated discussion of SNMP operation. SNMP is a complex utility managed exclusively by whatever SNMP 'Manager' (monitoring equipment) is employed. Refer to all instructions supplied with, and for, the SNMP Manager hardware and/or software in setting-up the 552.

EMAIL

Email and Text Notifications NOTE: The time-stamp feature for email notifications and the Alarm Log depends on a network connection to sync with Internet time, along with setting the proper time zone and other options. This is detailed under the next subheading.

Connected to the Internet, the 552 can send email or SMS/text notifications of reception or programming errors to one or more recipients. Which alarms go to which recipient is a separate setup routine.

SMTP Setup The 552 must first be properly programmed to send mail under SMTP Settings. You need to set up an actual email account, the elements of which are just like setting up any conventional email account. Information to be entered here depends on the provider you choose. When you apply for the account, much of this information will be assigned to you. Consult your IT professional for setting up email accounts if you need help.

Under SMTP Server:, enter the provided outgoing mail server info (e.g.: smtp.gmail.com), the required Port: number and whether TLS: is On or Off.

From: is the 'friendly' name that identifies the 552 to the email or SMS/text recipient. You could use station call letters or something like ModMonAlarm. User: is the full email address (username) of the email account you're using for the 552, and Password: the password you choose for this account.

**Recipients,
(Send To)**

Next enter up to ten email recipients, typing-in the full email address. After this you'll decide who gets what alert.

Email addresses typically take the form of the upper example here. If instead you wish to send a text message to a recipient's cell phone, the entry may look like the second image. In this instance the alarm notifications are being directed to a Verizon subscriber's phone. Further information on these naming protocols is available on the Web, or you can check with the wireless carrier to confirm the proper addressing style for Internet texting delivery.



When all recipients have been entered, click Save. You may also click Send Test Email, which will message all recipients to confirm proper communications setup. The Status: field will show whether the test message has been properly formatted, dispatched and accepted by the email provider.

**Notifications,
(Send What)**

You can assign any or all alarms to any or all email or text addresses in the Notifications section.

Referring to the example here, click the down arrow and choose a recipient 1. through 10. With a Recipient: selected, click the Send Emails For: boxes to choose which alarm conditions will be reported, or alarm logs dispatched, to that individual.

In this abbreviated example, the Chief Engineer will receive a text message on his phone for Overmod and Low Signal alarms. When you've finished with this Recipient:, proceed to the next. No Save command is necessary in this operation.

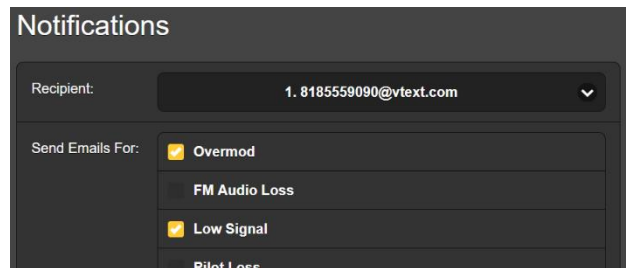

TIME SETUP

Time and DST

The onboard Real Time Clock updates from Internet Time daily and has sufficient inherent precision to remain accurate throughout the day. Grab and drag the Time Zone (Hours): slider for the proper offset from UTC (Universal Coordinated Time) for your location.

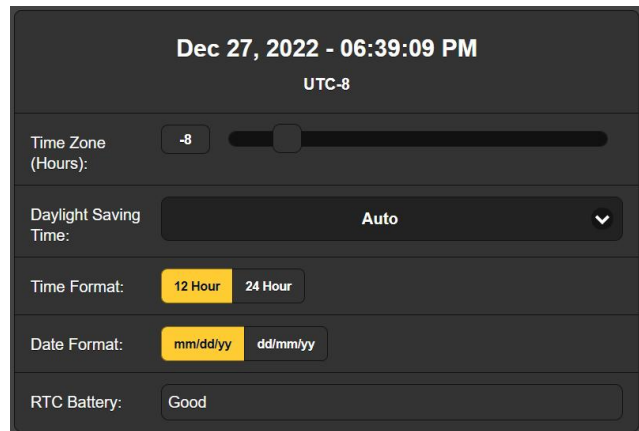

In this example, the -8 represents West Coast US (Pacific) time. The time at the top of the page will update quickly, so you can simply drag the slider until the time shown here agrees with that Rolex the PD gave you for doing such a good job.

Daylight Saving Time: is set to the default Auto mode in this example. You may either opt for this convenience, or click the down arrow to select On or Off for DST.

Presentation Formats

Time Format: can show either a 12 Hour or a 24 Hour clock, and the Date Format: can reflect either US or European conventions. The date is also automatically set by the Internet Time Server.

RTC Battery

The Real Time Clock has a backup battery located on the main 552 circuit board. This is a 3V CR2032 flat 'coincell' battery with the + side facing up. Replace the battery when RTC Battery: does not show Good.

Time Server

We have provided a reliable default time server, which is 1.inovonicsinc.pool.ntp.org. If you prefer another, overtype the Server: entry with your alternate and click Save.

ADMINISTRATIVE MATTERS

Security and Passwords

552 access may be protected by multilevel passwords, which must then be entered before screens can be seen or entries changed.

NOTE:

All passwords will be visible on the front-panel OLED Security menu after the Front Panel PIN has been entered.

All passwords are hidden on the Admin Webpage when logged-in as a 'Read Only Web User'.

Under the Security heading of the Admin Webpage, type-in a Front Panel PIN:. You may also enter this manually from the front panel under Security. Use numerals 0-9, enter one to ten digits.

This number must then be entered, plus **Save**, from the front-panel screen at the equipment site. The front-panel will remain unlocked until the **Display Timeout** expires.

There are two Webpages-access passwords. Web Admin Password (Read/Write): is the Administrator password that allows full access to the 552. Web User Password (Read Only): allows the lower-level user to view all data, but those users cannot retune the receiver or make changes to any settings. After the front-panel PIN and passwords have been assigned and entered, click **Save** to lock them into nonvolatile memory.

Once passwords have been entered and saved, Now Playing information will be the only front-panel data visible, and all Web interface screens will be locked out.

Signing In

Once password protection is in place, at the installation site you will be prompted to enter the front panel PIN using the knob before any menu can be accessed. Use the on-screen entry box and select **Save**. This will be necessary each time the unit times out to a dark or dim screen.

One or the other of the Webpages password must be entered on any connecting device. When this image appears on your screen, ignore Username and enter either the Web Admin or the Web User password into the Password field, then click Sign in.

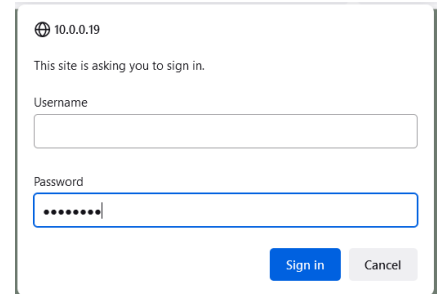

Lost Password (Hard Reset)

NOTE: A 'hard reset' is required to bypass a local or a Web interface password. *This must be done at the installation site!* A hard reset not only deletes the password, but will also return the 552 to all-factory-default settings. *All User settings will be lost!* This illustrates the importance of keeping a Hardware Profile current, which is discussed next.

If the password is lost, the only way you can recover control of the 552 is at the equipment site following this procedure:

1. Disconnect AC mains power.
2. Wait 10 seconds and then hold down the SELECT knob while you reapply AC power.
3. You should see confirmation on the LCD that the 552 is **Loaded Factory Defaults**. If this is NOT the case, if the unit boots starting with the usual **Booting Tuner, Booting HD Radio, Booting DSP** sequence, perform the sequence again.

The Hardware Profile

The entire 552 'setup' may be saved to your computer as a small text file. The Hardware Profile includes user settings, alarm notification preferences, SNMP options, passwords, etc., and is useful for restoring a previous setup or for cloning a second unit for backup service.

To save a profile to your computer, under Configuration click: Download Hardware Profile. With the Firefox browser used in this example, Windows first asks whether to Open or Save the file. After clicking the Save button and OK, Windows saves the file to the Windows Downloads folder. From there you can move it to a location of your choice. Other browsers may ask you directly to specify a Save as: location. The file carries a default name of 552_settings.json.

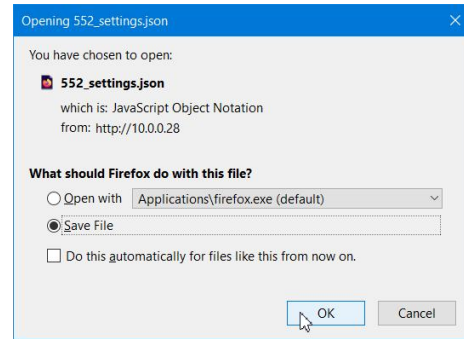

To upload (restore) saved settings, first click Select Hardware Profile... under Configuration and navigate to where you have saved the profile. When prompted, Open the file. Then click Upload Hardware Profile. This will replace all setup parameters currently loaded and running in your 552 with the saved ones.

Reboot Uploading a Hardware Profile *automatically* reboots the 552. There may be other circumstances under which you might want to reboot the unit manually. This can be done by clicking Reboot in the Configuration area.

A *manual* reboot does not change any settings or purge any data that would not be lost with a power cycle. The 552 will come back tuned to the same station and with all settings intact.

However, at any time you wish to ‘clean house’ and restore all settings and preferences to factory values, click: Load Factory Defaults. In this case you will lose your settings, except for IP settings (to maintain access to the unit), so doing a Download Hardware Profile first might be a good idea.

Updating Firmware 552 firmware includes the Web interface pages, and updates are easily uploaded to the unit when issued by Inovonics.

NOTE: We recommend saving a fresh Hardware Profile, as a firmware update may affect user settings. If there is danger of compromising stored data, the firmware update will include notes to that effect.

Updates are issued as small .bin files which may be downloaded to your computer Desktop or placed in any convenient folder. From the Firmware Update utility at the bottom of the Admin screen, click Select Firmware File... and double-click the .bin file listing. This will transfer the file to the updater as shown in the next screenshot.

Configuration

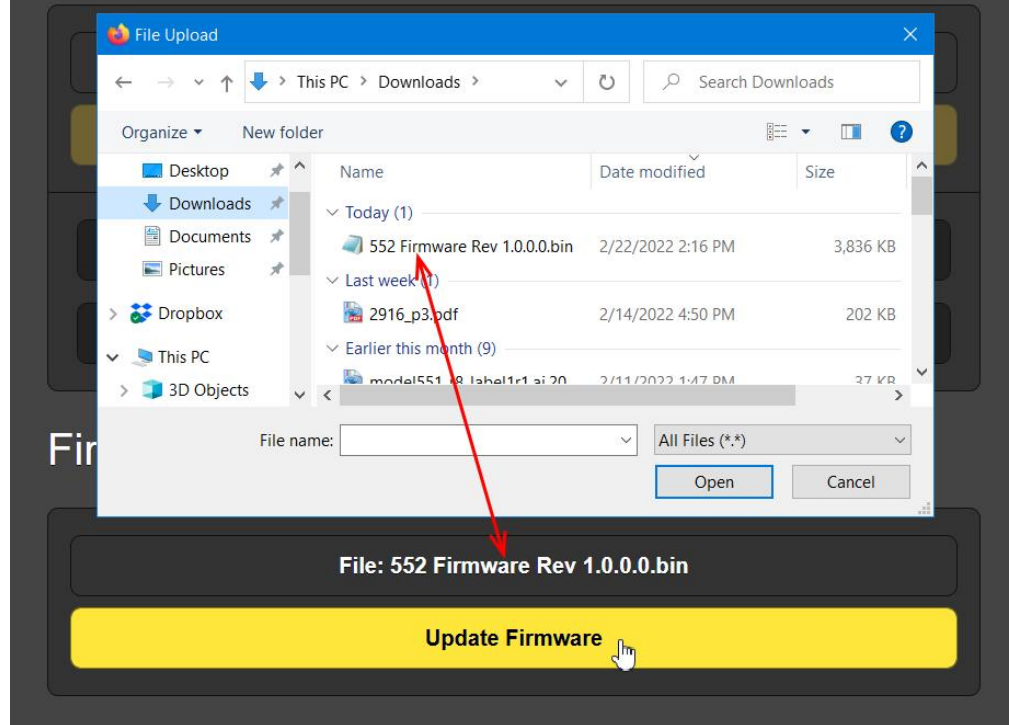

With the name of the new .bin showing in File:, Click Update Firmware and follow prompts to complete the process. Updating takes a minute or so and will return you to the new Web interface pages once the operation is complete.

552 Manual **'About' Info**

A PDF of the 552 manual has been included in the firmware.

The bottom of the Admin screen shows the Serial Number: of your 552, gives the current Firmware Rev: and displays the Uptime:, or how long your 552 has been running since power was last applied. You also may click Check for Updates to see if a new version of the firmware has been issued, and view Open Source Licenses boilerplate.

(Blank Page)



INOVONICS WARRANTY

- I TERMS OF SALE:** Inovonics products are sold with an understanding of “full satisfaction”; that is, full credit or refund will be issued for products sold as new if returned to the point of purchase within 30 days following their receipt, provided that they are returned complete and in an “as received” condition.
- II CONDITIONS OF WARRANTY:** The following terms apply unless amended *in writing* by Inovonics, Inc.
- A. Register the Warranty online at www.inovonicsbroadcast.com within 10 days of delivery.
 - B. This Warranty applies only to products sold “as new.” It is extended only to the original end-user and may not be transferred or assigned without prior written approval by Inovonics.
 - C. This Warranty does not apply to damage caused by misuse, abuse, accident or neglect. This Warranty is voided by unauthorized attempts at repair or modification, or if the serial identification label has been removed or altered.
- III TERMS OF WARRANTY:** Inovonics, Inc. products are warranted to be free from defects in materials and workmanship.
- A. Any discrepancies noted within THREE YEARS of the date of delivery will be repaired free of charge, or will be replaced with a new or remanufactured product at Inovonics’ option.
 - B. Parts and labor for factory repair required after the three-year Warranty period will be billed at prevailing prices and rates.
- IV RETURNING GOODS FOR FACTORY REPAIR:**
- A. Equipment will not be accepted for Warranty or other repair without a Return Authorization (RA) number issued by Inovonics prior to its return. An RA number may be obtained by calling the factory. The number should be prominently marked on the outside of the shipping carton.
 - B. Equipment must be shipped prepaid to Inovonics. Shipping charges will be reimbursed for valid Warranty claims. Damage sustained as a result of improper packing for return to the factory is not covered under terms of the Warranty and may occasion additional charges.

